



WHISTLER TEMPORARY USE PERMIT - CANNABIS RETAIL

RESORT MUNICIPALITY OF WHISTLER
4325 Blackcomb Way TEL 604 932 5535
Whistler, BC Canada V8E 0X5 TF 1 866 932 5535
whistler.ca FAX 604 935 8109

Application Number _____
TUP _____
Work Order: _____

Climate Action, Planning and Development Services - Planning Department
Tel 604-935-8170 (direct)
Email: planning@whistler.ca

Application Type: (check applicable boxes)

- Temporary Use Permit – (Cannabis Retail) Temporary Use Permit – amendment or renewal

Please review the R_MOW Cannabis Retail Policy No. G-27 and ensure this application complies with requirements and stipulations of the policy.

Subject Property:

Street Address: 201A & 201B 4293 Mountain Square, Whistler, BC, V0N1B4

Legal Description P.I.D. 010-879-315
(On Land Title Certificate)

Please check the TUP Area the proposed business is located in:

- Creekside Function Junction Nesters Plaza
 The Village Village North

Property Zoning: CC1

Business Information:

Legal Name: 1211633 BC Ltd

Doing Business As: This Is Cannabis

Mailing Address: 107-7670 Vedder Rd, Chilliwack, BC, V2R 4G9

Provincial Application Reference Number: Job # 050992

Name of Applicant/Agent: Cody Les



Name of Registered Property Owner: Wei He (Mountain Square Holdings Ltd)

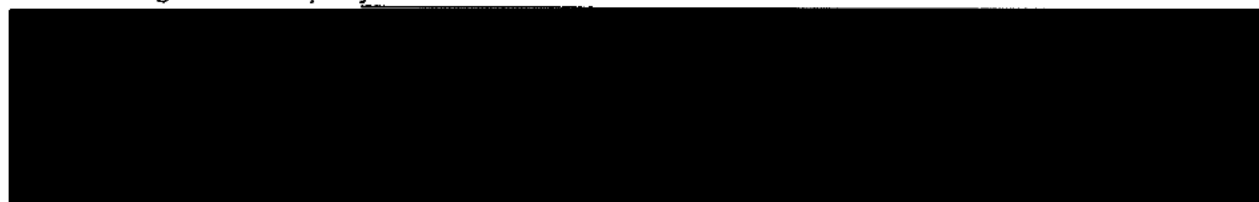

AUTHORIZATIONS

I WEI HE (Mountain Square Holdings Ltd.) authorize CODY LES (1211633 B.C. LTD.)
(PRINT NAME of registered property owner) (PRINT NAME of agent/person authorized to sign the application)

to act as agent and sign the application form to the Resort Municipality of Whistler on my/our behalf for the property known as

201 - 4293 Mountain Square, Whistler, BC

(Civic address of property)

Signature(s) of registered property owner(s) _____ Date FEB 17, 2023

Signature(s) of Signing Officer(s) of Corporation _____ Corporate Seal(s), if applicable _____ Date _____
 WEI HE (Director of Mountain Square Holdings Ltd.)

PROPERTY OWNER'S AGREEMENT

As of the date of this application, I am the registered owner of the lands described in the application. I have examined the contents of the application, certify that the information submitted with it is correct insofar as I have knowledge of these facts, and concur with the submission of the application. I acknowledge that the lands described in the application may be subject to applicable laws, regulations, and guidelines including, but not limited to, the Resort Municipality of Whistler Zoning and Parking Bylaw No. 303, 2015 and the *Local Government Act*. I agree to comply with all provisions of the Resort Municipality of Whistler Zoning and Parking Bylaw No. 303, 2015 and any other applicable legislation, if this application is approved. I understand that approval does not constitute a building permit and that drawings submitted for a building permit must match approved Temporary Use Permit drawings.

Signature of property owner _____ Date FEB 17, 2023
 WEI HE (Director of Mountain Square Holdings Ltd.)

DECLARATION

I Cody Les, solemnly declare that the statements made
(PRINT NAME)

by me upon this application are to the best of my belief and knowledge a true and complete representation of the purpose and intent of this application.

Signature of applicant or agent _____ Date MARCH 13, 2023

FEE SCHEDULE

| TEMPORARY USE PERMITS | Fees | Select |
|--|------------|-------------------------------------|
| Temporary Use Permit – requiring Council consideration of issuance | \$4,700.00 | <input type="checkbox"/> |
| Temporary Use Permit – amendments or renewals | \$3,525.00 | <input type="checkbox"/> |
| Other Services By Request | | |
| Land Title Search by Request | \$35.00 | <input type="checkbox"/> |
| CANNABIS RETAIL LICENCE APPLICATION PROCESSING FEE | | |
| New Cannabis Retail Store Licence | \$2,000.00 | <input checked="" type="checkbox"/> |

SUBMITTAL REQUIREMENTS – DOCUMENT CHECKLIST

Subject Property Civic Address: 201A & 201 B 4293 MOUNTAIN SQUARE, WHISTLER, BC V1G 1B4

Incomplete applications will not be accepted.

The items on the list are the minimum requirement for your application. Depending on the nature of your project, **you may be requested to submit additional information/documents** with, or following submission of, your application. Check and sign and include this document with your application.

For ALL applications:

Electronic PDF copies of all submissions; including application, drawings, and reports. Electronic files may be emailed to planning@whistler.ca.

Every report and document submitted in support of an application must contain an express grant of permission to the Resort Municipality of Whistler to use, reproduce and publish the information contained in the report or document for non-commercial purposes.

| REQ | N/A | SUBMISSION ITEMS CHECKLIST |
|---|--------------------------|---|
| <input checked="" type="checkbox"/> | <input type="checkbox"/> | 1. Complete and signed Application Form, Document Checklist and application fee. |
| <input checked="" type="checkbox"/> | <input type="checkbox"/> | 2. Title Search (issued not more than 30 days from the date application is received) OR a \$35.00 Title Search Fee in lieu (per PID). |
| <input checked="" type="checkbox"/> | <input type="checkbox"/> | 3. Strata authorization on form attached for all proposals affecting common property on a strata plan. |
| <input checked="" type="checkbox"/> | <input type="checkbox"/> | 4. Provincial Referral or Proof of Provincial Application. Application submitted to LCRB for municipal review and comment |
| PDF of the following submission items and plans as may be relevant to illustrate the proposal. All drawings must include a bar scale and a north arrow. | | |
| <input checked="" type="checkbox"/> | <input type="checkbox"/> | 5. Community Impact Statement <ul style="list-style-type: none"> Must address the guiding principles, location guidelines and evaluation criteria in Cannabis Retail Policy G-27 Must outline how the business will address the relevant RMOW policies and contribute to Whistler’s priorities, goals and vision as outlined in Whistler’s Official Community Plan, including economic, social and environmental impacts the business may have on the surrounding neighbourhood and wider community, and strategies for mitigating potential negative impacts. |
| <input checked="" type="checkbox"/> | <input type="checkbox"/> | 6. Commitment to signing and adhering to a Good Neighbour Agreement <ul style="list-style-type: none"> Application should indicate the business’ commitment to addressing nuisance issues and working collaboratively |
| <input checked="" type="checkbox"/> | <input type="checkbox"/> | 7. Business Plan – Full description of the proposed business operation, including the following information: <ul style="list-style-type: none"> Past business experience Corporate structure Number of staff, products sold, target market, and hours of operation Any proposed educational initiatives and strategies regarding nuisance, consumption and cannabis-related issues Insurance coverage information |
| <input checked="" type="checkbox"/> | <input type="checkbox"/> | 8. Context Plan - Scale of 1:500 (minimum) or imperial equivalent. If imperial equivalent all dimensions must be labelled in both imperial and metric. Include: <ul style="list-style-type: none"> Location of property including adjacent streets. Distance to nearest property line of any parcel containing a school or the Meadow Park Recreation Centre. Photographs showing the subject property and all adjacent development. <p>Note: (a) A cannabis retail store shall not be permitted within 300 metres of the nearest property line of any parcel containing a school or the Meadow Park Recreation Centre. (b) A cannabis retail store shall not be permitted to have frontage on the Village Stroll</p> |
| <input checked="" type="checkbox"/> | <input type="checkbox"/> | 9. Design Proposal <ul style="list-style-type: none"> Site Plan Dimensioned floor plans showing all doors, exits/entrances, cash registers, location of fixed shelving or displays, and location of all areas open to the public, space designated for staff and storage areas. Exterior elevations/sections clearly illustrating and labelling exterior building materials, finishes and colors; signage location and size; and lighting Demonstrate security measures in compliance with or exceed LCRB requirements Parking plan, if applicable |

| | |
|--|---|
| | Odour control and store ventilation details |
|--|---|

Additional Information

During the review process additional information requirements may be required if the proposed activity is reasonably expected to have an impact on any matters contained in the applicable RMOW policies and bylaws.

COPY LES .

Full name of applicant or agent (Print)

[Redacted Signature]

Signature of applicant or agent

MARCH 13, 2023

Date

Personal information is being collected under the authority of the *Local Government Act* for the purpose of processing this Development Permit application. This information is protected under the privacy provisions of the *Freedom of Information and Protection of Privacy Act*. If you have any questions about the collection of this information, contact the Director of Planning at 604-935-8170, Resort Municipality of Whistler, 4325 Blackcomb Way, Whistler, BC V8E 0X5.



RESORT MUNICIPALITY OF WHISTLER
 4325 Blackcomb Way TEL 604 932 5535
 Whistler, BC Canada V8E 0X5 TF 1 866 932 5535
 whistler.ca FAX 604 935 8109

STRATA COMMON PROPERTY REPRESENTATION OF AUTHORITY

#201- 4293 Mountain Square, Whistler

Strata Plan VR2126

PROPERTY CIVIC ADDRESS

STRATA CORPORATION NO.

The undersigned, on behalf of Strata Corporation No. VR2126 (the "Strata Corporation"), in consenting to the application (the "Application") of _____, the owner of Strata Lot No. 1, 2, 3 for an application to which the Resort Municipality of Whistler "Land Use Procedures and Fees Bylaw No. 2205, 2022" applies to alter the Common Property of Strata Plan No. VR2126, being a Strata Manager (holding a valid license) licensed under the *Real Estate Services Act*, represents to the Resort Municipality of Whistler (the "RMOW") that we are authorized to consent to the Application on behalf of the Strata Corporation and that all appropriate resolutions of the Strata Corporation have been duly passed to authorize the proposed changes or alterations to the Common Property.

In the case where the Strata Corporation is not represented by a licensed Strata Manager the undersigned hereby represent to the RMOW that we are members of the Strata Council duly elected in accordance with the *Strata Property Act*, that we are legally authorized to consent to the Application on behalf of the Strata Corporation and that all appropriate resolutions of the Strata Corporation have been duly passed to authorize the proposed changes or alterations to the Common Property.

In making the above representation, the Strata Corporation acknowledges that the RMOW is relying on our representation in accepting the Application and issuing the Permit and the Strata Corporation releases the RMOW from any and all liabilities if the representation is untrue or inaccurate.

PLEASE COMPLETE THE FOLLOWING IF STRATA MANAGEMENT COMPANY IS PROVIDING REPRESENTATION OF AUTHORITY:

WRM strata management and real estate services ltd.

STRATA MANAGEMENT COMPANY NAME* (PLEASE PRINT)

Ross Redman



STRATA MANAGER NAME* (PLEASE PRINT)

STRATA MANAGER SIGNATURE

SIGNED THIS 23 DAY OF February 2023

PLEASE COMPLETE THE TABLE ON PAGE OVER IF STRATA COUNCIL MEMBERS ARE PROVIDING REPRESENTATION OF AUTHORITY.



WHISTLER

STRATA COMMON PROPERTY REPRESENTATION OF AUTHORITY

Page 2

PLEASE COMPLETE THE FOLLOWING IF STRATA COUNCIL MEMBERS ARE PROVIDING REPRESENTATION OF AUTHORITY:

COUNCIL MEMBER NAME* (PLEASE PRINT)

STRATA LOT NO: _____

COUNCIL MEMBER SIGNATURE

SIGNED THIS _____ DAY OF _____ 20____

COUNCIL MEMBER NAME* (PLEASE PRINT)

STRATA LOT NO: _____

COUNCIL MEMBER SIGNATURE

SIGNED THIS _____ DAY OF _____ 20____

The Strata Title Act requires that permission from a Strata Corporation be obtained whenever construction affects Common Property. Written approval from the Strata Corporation is required whenever the proposed work involves Common Property or Limited Common Property.

"common property" means

- (a) that part of the land and buildings shown on a strata plan that is not part of a strata lot, and
- (b) pipes, wires, cables, chutes, ducts and other facilities for the passage or provision of water, sewage, drainage, gas, oil, electricity, telephone, radio, television, garbage, heating and cooling systems, or other similar services, if they are located
 - (i) within a floor, wall or ceiling that forms a boundary
 - (A) between a strata lot and another strata lot,
 - (B) between a strata lot and the common property, or
 - (C) between a strata lot or common property and another parcel of land, or
 - (ii) wholly or partially within a strata lot, if they are capable of being and intended to be used in connection with the enjoyment of another strata lot or the common property;

"limited common property" means common property designated for the exclusive use of the owners of one or more strata lots;

INFORMATION SIGN REQUIREMENTS

Applications are subject to the Resort Municipality of Whistler "Land Use Procedures and Fees Bylaw No. 2205, 2022" information sign requirements.

1. An information sign is required to be posted for all applications for:
 - development permit,
 - development permit under a land use contract,
 - approval of a Development Plan or Development Approval under the *Blackcomb Land Use Contract*,
 - development variance permit,
 - temporary use permit,
 - modification or discharge of a section 219 covenant,
 - exemption from a bylaw establishing a flood construction level or floodplain setback,
 - amendment to the Official Community Plan,
 - amendment to the Zoning Bylaw, and
 - amendment to a land use contract.
2. The applicant must prepare and **post an information sign on the land that is the subject of the application within 14 days of making the application** and notify planning@whistler.ca that the sign has been posted via an email containing a photo of the installed sign. (Please download and fill in the [Development Application Sign Template](#) using Adobe Acrobat or similar pdf viewer/editor)
3. The information sign must conform generally to the written specifications contained on the following page of this handout and must also include the following:
 - A map of the site containing a North Arrow, with all the roads adjoining the development site labelled (insert as top image on the fillable [Development Application Sign Template](#));
 - A rendering of the proposed development for development permit applications requiring Council consideration and for zoning amendments with a design component (insert as bottom image on the fillable [Development Application Sign Template](#)). For all other application types, leave the bottom image blank;
 - The abovementioned images can be inserted using Adobe Acrobat or another similar pdf viewer/editor. **The ideal aspect ratio for the image(s) is 947:591.**
4. The information sign must be 4' (1220 mm) x 6' (1829mm) in size.
5. Notification signs must be placed in a conspicuous location, be clearly legible from adjoining streets, and not be obstructed by vegetation or structures on the land, and is required to be placed every 100 metres of highway/road frontage of the subject parcel, except that no more than 3 signs are required for any one parcel.
6. The applicant must keep the notification sign posted and in good repair until the application has been approved or refused by Council or its delegate, or has been withdrawn by the applicant.
7. The applicant must remove the notification sign within 14 days of the application being approved or refused by Council or its delegate, or being withdrawn by the applicant. The municipality may remove the notification sign at the expense of the applicant subject to the municipality first giving notice of the non-compliance of the 14 day removal requirements.

SAMPLE ONLY: PLEASE DOWNLOAD THE FILLABLE "DEVELOPMENT APPLICATION SIGN TEMPLATE" HERE

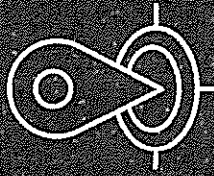

DEVELOPMENT APPLICATION

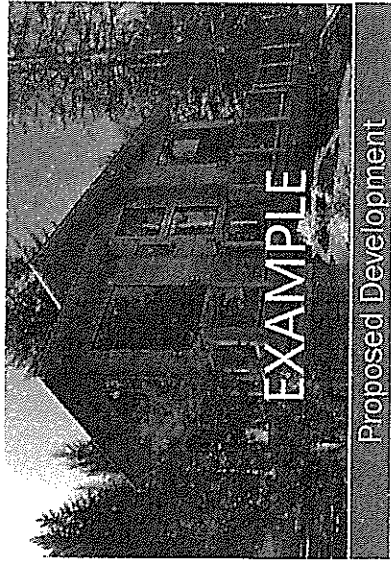
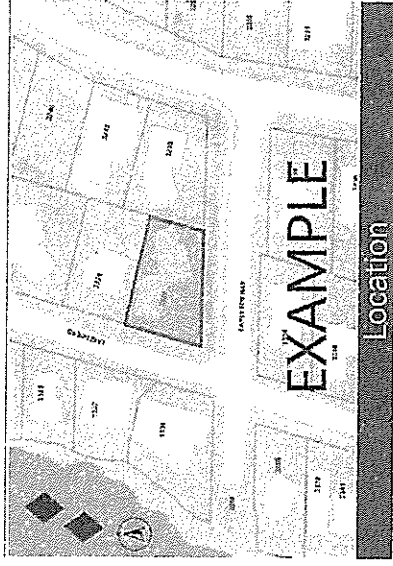

Application No: eg. DP001800

Address:

Applicant Name:

Type of Application: eg. Development Permit

Insert brief description of the proposal including proposed uses, number and type of units, proposed gross floor area and proposed building heights (in metric units).

List all proposed variances.

Include the following text: "The details of the proposed development may be revised during the application process."

FOR MORE INFO:



604 935 8170

whistler.ca/ourcity

planning@whistler.ca



Resort Municipality of

WHISTLER



Job # 050992

May 10, 2022

Via email: planning@whistler.ca

Megan Mucignat
Policy Planner
Resort Municipality of Whistler

Dear: Megan Mucignat

Re: Application for a Non-Medical Cannabis Retail Store Licence
Applicant: 1211633 B.C. LTD.
Proposed Establishment Name: This Is Cannabis
Proposed Establishment Location: 201-4293 Mountain Square, Whistler ,V8E1B8

The Applicant, 1211633 B.C. LTD., has applied to the Liquor and Cannabis Regulation Branch (LCRB) for a Non-Medical Cannabis Retail Store (CRS) licence proposed to be located at the above-noted address. The applicant contact is Cody Les. They can be reached at [REDACTED] or via email at [REDACTED]

Local governments and Indigenous nations are a crucial part of the licensing process. Section 33(1) of the *Cannabis Control and Licensing Act* prevents the LCRB from issuing a CRS licence without a positive recommendation regarding the CRS licence application from the local government or Indigenous nation.

The LCRB is requesting the Resort Municipality of Whistler to consider the application and provide the LCRB with a written recommendation with respect to the application. To assist with your assessment of the application, a site map of the proposed cannabis retail store is attached. The following link opens a document which provides specific and important information and instructions on your role in the CRS licensing process, including requirements for gathering the views of residents.

<https://www2.gov.bc.ca/gov/content/employment-business/business/liquor-regulation-licensing/local-gov-indigenous-nations/role-of-local-governments-and-indigenous-nations-in-cannabis-retail-licensing>

The LCRB will initiate an applicant suitability assessment regarding this CRS application, also known as a “fit and proper” assessment of the applicant and persons associated with the applicant. Once the assessment is complete, you will be notified of the LCRB’s determination. You may choose to withhold your recommendation until the LCRB has made a final decision regarding the applicant’s suitability.

Liquor and Cannabis
Regulation Branch

Mailing Address:
PO Box 9292 Stn Prov Govt
Victoria BC V8W 9J8

Location:
645 Tyee Road
Victoria BC V9A 6X5
Phone: 250 952-5787
Facsimile: 250 952-7066

Website:
www.gov.bc.ca/cannabisregulationandlicensing



If you choose not to make any recommendation regarding this application, please contact the LCRB at the earliest convenience. Please note that a Cannabis Retail Store Licence cannot be issued unless the LCRB receives a positive recommendation from the local government or Indigenous nation. Similarly, if a local government or Indigenous nation decides not to make any recommendation, the LCRB will not consider the application any further.

If you have any questions regarding this application, please contact me at (778) 698-5310 or Lauren.Clarke@gov.bc.ca

Sincerely,



Lauren Clarke
Senior Licensing Analyst

Attachment – Site Map

copy: 1211633 B.C. LTD.

MACDONALD COMMERCIAL
 REAL ESTATE SERVICES LTD.
 1827 W 5th Ave
 Vancouver, BC V6J 1P5
 Tel (604) 736-5611
 Fax (604) 736-7976
 www.macdonaldcommercial.com

4293 MOUNTAIN SQUARE
 WHISTLER, BC

PLAZA
 FLOOR PLAN

Measured: June 22, 2017
 Updated: Sep 25, 2017

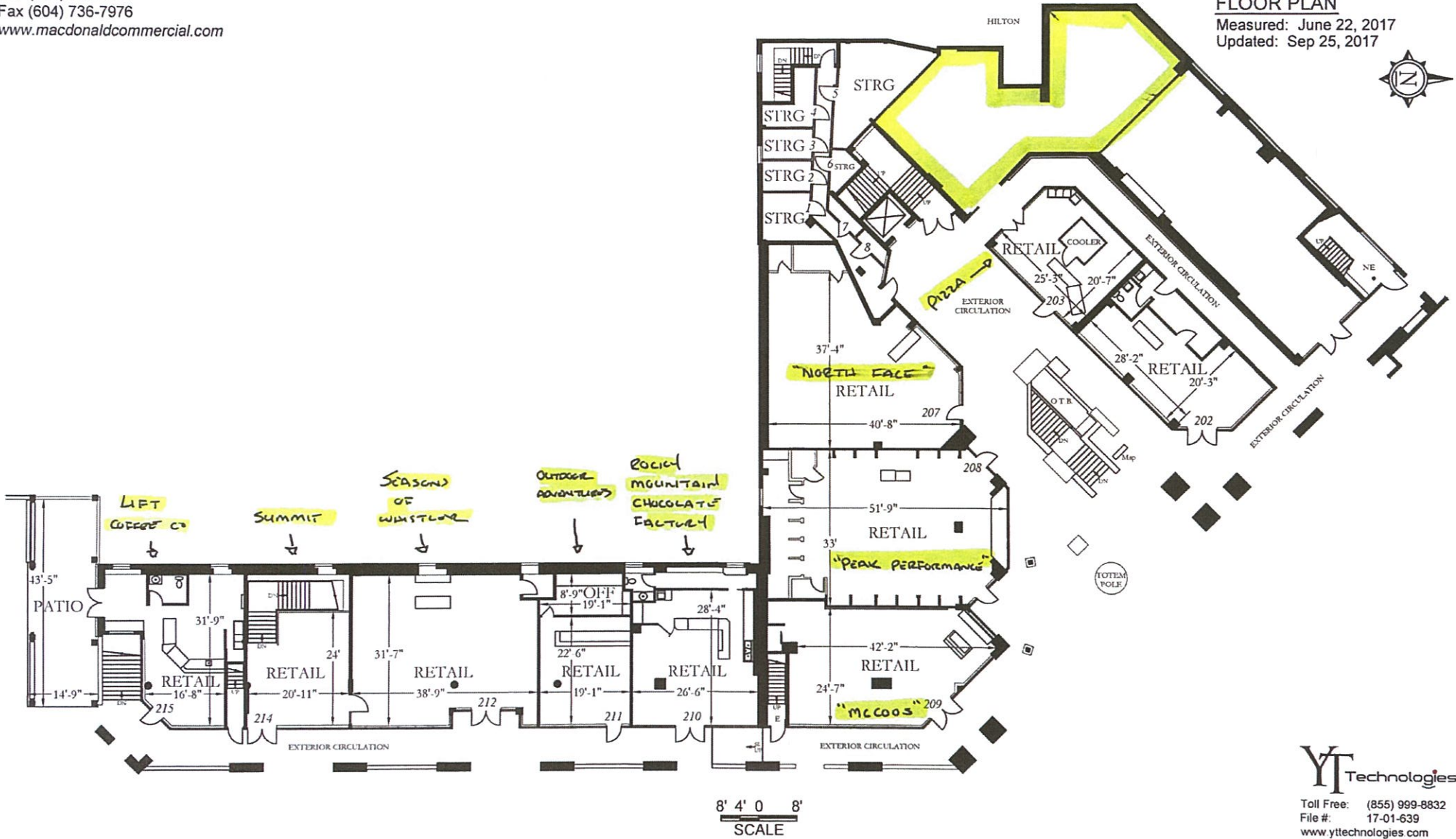

CURRENT INFORMATION ONLY - NO CANCELLED INFORMATION SHOWN

Title Issued Under STRATA PROPERTY ACT (Section 249)

Land Title District VANCOUVER
Land Title Office VANCOUVER

Title Number CA5155276
From Title Number CA2600331

Application Received 2016-05-02

Application Entered 2016-05-12

Registered Owner in Fee Simple
Registered Owner/Mailing Address: MOUNTAIN SQUARE HOLDINGS LTD., INC.NO. 0842971
UNIT 2535 - 3700 NO. 3 ROAD
RICHMOND, BC
V6X 3X2

Taxation Authority Whistler, Resort Municipality of

Description of Land
Parcel Identifier: 010-879-315
Legal Description:
STRATA LOT 3 DISTRICT LOT 3020 STRATA PLAN VR. 2126 TOGETHER WITH AN INTEREST
IN THE COMMON PROPERTY IN PROPORTION TO THE UNIT ENTITLEMENT OF THE STRATA
LOT AS SHOWN ON FORM 1.

Legal Notations

THIS TITLE MAY BE AFFECTED BY A PERMIT UNDER PART 26 OF THE LOCAL
GOVERNMENT ACT, SEE BB1347372

THIS TITLE MAY BE AFFECTED BY A PERMIT UNDER PART 26 OF THE LOCAL
GOVERNMENT ACT, SEE BB297015

THIS TITLE MAY BE AFFECTED BY A PERMIT UNDER PART 26 OF THE LOCAL
GOVERNMENT ACT, SEE BB767816

HERETO IS ANNEXED EASEMENT BW410680 OVER PART (PLAN BCP13152) OF
THE COMMON PROPERTY STRATA PLAN VR1218

TITLE SEARCH PRINT

2023-02-21, 14:42:56

File Reference: 1

Requestor: Darcy Mallam

HERETO IS ANNEXED EASEMENT BW410682 OVER PARTS (PLANS BCP13154 AND BCP13155) OF THE COMMON PROPERTY OF STRATA PLAN VR1218

HERETO IS ANNEXED EASEMENT BW52135 OVER PART (PLAN BCP9449) OF THE COMMON PROPERTY OF STRATA PLAN VR1218

HERETO IS ANNEXED EASEMENT BW52149 OVER STRATA LOT 1 STRATA PLAN VR2126

HERETO IS ANNEXED EASEMENT BW52152 OVER STRATA LOT 2 STRATA PLAN VR2126

HERETO IS ANNEXED EASEMENT BW52154 OVER THE COMMON PROPERTY OF STRATA PLAN VR2359

HERETO IS ANNEXED EASEMENT BW52155 OVER THE COMMON PROPERTY OF STRATA PLAN VR1218

HERETO IS ANNEXED EASEMENT BW52165 OVER PART (PLANS BCP9462, BCP9463, BCP9467 AND BCP9468) OF THE COMMON PROPERTY OF STRATA PLAN VR1218

HERETO IS ANNEXED EASEMENT BW52166 OVER PART (PLAN BCP9463) OF STRATA LOT 2 STRATA PLAN VR1218

HERETO IS ANNEXED EASEMENT BW52168 OVER PART (PLAN BCP9467) OF STRATA LOT 4 STRATA PLAN VR1218

HERETO IS ANNEXED EASEMENT BW52169 OVER PART (PLAN BCP9467) OF THE COMMON PROPERTY OF STRATA PLAN VR1218

HERETO IS ANNEXED EASEMENT BW52170 OVER PART (PLAN BCP9468) OF STRATA LOT 29 STRATA PLAN VR1218

HERETO IS ANNEXED EASEMENT BW52171 OVER PART (PLAN BCP9468) OF THE COMMON PROPERTY STRATA PLAN VR1218

HERETO IS ANNEXED EASEMENT BX349862 OVER PART OF THE COMMON PROPERTY STRATA PLAN VR1218 SHOWN ON PLAN BCP18592

HERETO IS ANNEXED EASEMENT BX349863 OVER THE COMMON PROPERTY STRATA PLAN VR1218

NOTICE OF INTEREST, BUILDERS LIEN ACT (S.3(2)), SEE CA1050711
FILED 2009-02-27

THIS LAND MAY BE SUBJECT TO SECTIONS 14 TO 22 OF THE RESORT
MUNICIPALITY OF WHISTLER ACT AND THE BYLAWS OF THE WHISTLER RESORT
ASSOCIATION FILED UNDER THE SOCIETIES ACT, SEE DF G87899
MODIFIED BY DF BG106166 31.03.1993

THIS TITLE MAY BE AFFECTED BY A PERMIT
UNDER PART 29 OF THE MUNICIPAL ACT.
SEE D.F. BH399551 (EXPIRES ON N/A)

Charges, Liens and Interests

Nature: STATUTORY RIGHT OF WAY
Registration Number: H94603
Registration Date and Time: 1980-11-17 14:53
Registered Owner: RESORT MUNICIPALITY OF WHISTLER
Remarks: INTER ALIA
PART IN EXPLANATORY PLAN 15333

Nature: COVENANT
Registration Number: H94606
Registration Date and Time: 1980-11-17 14:56
Registered Owner: RESORT MUNICIPALITY OF WHISTLER
Remarks: INTER ALIA
L.T.A. S. 215
EXTENDED BY R104541 06/10/1987
MODIFIED BY GB89148, 09/08/1988

Nature: COVENANT
Registration Number: H94608
Registration Date and Time: 1980-11-17 14:58
Registered Owner: RESORT MUNICIPALITY OF WHISTLER
Remarks: INTER ALIA
L.T.A. S. 215, PART THEREIN DESCRIBED
MODIFIED BY GB89149, 09/08/1988 MODIFIED BY
K67873, 20/10/1982

Nature: COVENANT
Registration Number: K67873
Registration Date and Time: 1982-10-20 14:41
Registered Owner: RESORT MUNICIPALITY OF WHISTLER
Remarks: INTER ALIA
L.T.A. S. 215, PART THEREIN DESCRIBED MODIFICATION
OF COVENANT H94608

TITLE SEARCH PRINT

2023-02-21, 14:42:56
Requestor: Darcy Mallam

File Reference: 1

Nature: COVENANT
Registration Number: R104596
Registration Date and Time: 1987-10-06 15:09
Registered Owner: RESORT MUNICIPALITY OF WHISTLER
Remarks: INTER ALIA
S. 215 L.T.A.
PORTIONS IN EXPLANATORY PLANS 18695 AND 18696

Nature: STATUTORY RIGHT OF WAY
Registration Number: R104597
Registration Date and Time: 1987-10-06 15:10
Registered Owner: RESORT MUNICIPALITY OF WHISTLER
Remarks: INTER ALIA
PART IN EXPLANATORY PLAN 18698

Nature: STATUTORY RIGHT OF WAY
Registration Number: R104598
Registration Date and Time: 1987-10-06 15:10
Registered Owner: RESORT MUNICIPALITY OF WHISTLER
Remarks: INTER ALIA
PART IN EXPLANATORY PLAN 15333

Nature: COVENANT
Registration Number: GB89148
Registration Date and Time: 1988-08-09 10:04
Remarks: INTER ALIA
MODIFICATION OF COVENANT H94606 SEE R104541
SECTION 215, LAND TITLE ACT

Nature: COVENANT
Registration Number: GB89149
Registration Date and Time: 1988-08-09 10:04
Remarks: INTER ALIA
MODIFICATION OF COVENANT H94608, SEE K67873
SECTION 215, LAND TITLE ACT

Nature: RESTRICTIVE COVENANT
Registration Number: GB94383
Registration Date and Time: 1988-08-23 09:34
Remarks: APPURTENANT TO STRATA LOTS 4,5,6,7,8, AND 9
VR. 2126

TITLE SEARCH PRINT

2023-02-21, 14:42:56

File Reference: 1

Requestor: Darcy Mallam

Nature: EASEMENT
Registration Number: BW52143
Registration Date and Time: 2004-02-06 14:32
Remarks: PLAN BCP9450
APPURTENANT TO STRATA LOTS 1 TO 166 AND THE
COMMON PROPERTY OF STRATA PLAN VR1218 AND
STRATA LOTS 1 TO 127 AND THE COMMON PROPERTY OF
STRATA PLAN VR2359 AND
AIR SPACE PARCEL 2 AIR SPACE PLAN 19471 AND
AIR SPACE PARCEL A AIR SPACE PLAN 21463 AND
STRATA LOTS 1, 2 AND 4 TO 9 AND THE COMMON
PROPERTY OF STRATA PLAN VR2126

Nature: EASEMENT
Registration Number: BW52144
Registration Date and Time: 2004-02-06 14:32
Remarks: PLAN BCP9452
APPURTENANT TO STRATA LOTS 4 TO 9 AND
THE COMMON PROPERTY STRATA PLAN VR2126

Nature: EASEMENT
Registration Number: BW52153
Registration Date and Time: 2004-02-06 14:32
Remarks: APPURTENANT TO STRATA LOTS 1, 2 AND 4 TO 9
AND THE COMMON PROPERTY STRATA PLAN VR2126

Nature: EASEMENT
Registration Number: BW52167
Registration Date and Time: 2004-02-06 14:32
Remarks: PLANS BCP9464, BCP9465, BCP9466
APPURTENANT TO STRATA LOTS 1 TO 166 AND
THE COMMON PROPERTY STRATA PLAN VR1218

Nature: EASEMENT
Registration Number: BX349857
Registration Date and Time: 2005-07-08 13:45
Remarks: APPURTENANT TO LEASE BX349845

Nature: EASEMENT
Registration Number: BX349858
Registration Date and Time: 2005-07-08 13:45
Remarks: PART SHOWN AS 26 SQUARE METRES ON
PLAN BCP9450
APPURTENANT TO LEASE BX349845

TITLE SEARCH PRINT

2023-02-21, 14:42:56
Requestor: Darcy Mallam

File Reference: 1

Nature: MORTGAGE
Registration Number: CA9157030
Registration Date and Time: 2021-07-02 11:31
Registered Owner: BANK OF CHINA (CANADA)
Remarks: INTER ALIA

Nature: ASSIGNMENT OF RENTS
Registration Number: CA9157031
Registration Date and Time: 2021-07-02 11:31
Registered Owner: BANK OF CHINA (CANADA)
Remarks: INTER ALIA

Duplicate Infeasible Title NONE OUTSTANDING

Transfers NONE

Pending Applications NONE



THIS

CANNABIS

COMMUNITY IMPACT
STATEMENT

Contents

| | |
|--|----|
| COMMITMENT TO RECONCILIATION AND PROVIDING ECONOMIC OPPORTUNITIES FOR INDIGENOUS PARTNERS | 3 |
| RELATIONSHIPS WITH OR SUPPORT FOR COMMUNITY ORGANIZATIONS | 4 |
| Whistler Community Services Society (WCSS) | 4 |
| The Association of Whistler Area Residents for the Environment (AWARE) | 4 |
| Whistler Offroad Cycling Association (WORCA)..... | 4 |
| Whistler Chamber of Commerce..... | 5 |
| BALANCING RESORT AND COMMUNITY NEEDS | 5 |
| PROVISIONS FOR EMPLOYEE HOUSING | 5 |
| COMMITMENT TO A LIVING WAGE | 5 |
| LEADERSHIP ON SUSTAINABILITY AND CLIMATE ACTION | 6 |
| Whistler’s Climate Action Big Moves Strategy | 6 |
| Zero Waste Action Plan..... | 6 |
| STORE DESIGN | 7 |
| Exterior..... | 7 |
| Interior | 7 |
| SECURITY PLANNING | 7 |
| Physical Security Assessment (PSA) and Crime Through Environmental Design (CPTED) 7 | |
| Security Plan..... | 8 |
| NUISANCE MITIGATION PLANS | 9 |
| Impact on Visitors and Neighbours Including Odour | 9 |
| Commitment to Good Neighbour Agreement..... | 10 |
| Smoking Regulation Bylaw No. 2136, 2017 | 10 |
| INDUSTRY AND COMMUNITY SUPPORT LETTERS | 11 |

COMMITMENT TO RECONCILIATION AND PROVIDING ECONOMIC OPPORTUNITIES FOR INDIGENOUS PARTNERS

We acknowledge that the location of our proposed store is on the unceded and shared territory of the Skwxwú7mesh and Lílwat7úl peoples. In submitting this proposal to the Resort Municipality of Whistler, we have made significant efforts to ensure that we have actively engaged with the Nations so as to further reconciliation and economic opportunities, as outlined in the permit requirements set forth in Cannabis Retail Policy G-27.

Following these conversations, we have drafted a Letter of Undertaking (which can be referenced in Appendix D) through our lawyers committing ourselves to the following two initiatives upon commencing operation of the cannabis retail store in Whistler:

1. Create an annual \$50,000 scholarship fund with the Capilano University Foundation made available to Indigenous persons, with preference given to the Skwxwú7mesh and Lílwat7úl peoples, and
2. Provide an annual distribution equal to 2% of the location's yearly top-line revenue, projected to be approximately \$100,000 per year.

With respect to the annual distribution, we will approach each of the Nations through their respective community economic development companies (Skwxwú7mesh Nch'Kay Development Corporation and Lílwat7úl Economic Development Division), to offer each 50% of the annual distribution to be used for each Nation's community and economic development purposes, provided that:

if, within 60 days, only one Nations accepts the offer of the annual distribution, then the entire annual distribution will be made available to the accepting Band; and

if, after 60 days, neither Nation has accepted the offer of the annual distribution, or a portion thereof, the annual distribution will instead be divided into two parts, and paid out as follows:

- i. 50% will be offered and paid to the Whistler Community Services Society for its general community purposes, and
- ii. 50% will be placed in a fund created by our company to subsidize the housing costs of our employees amidst the current housing crisis within the RMOW.

For greater certainty, we will always be available and willing to formalize the commitments set forth within a more detailed contribution agreement negotiated with the Nations, Whistler Community Services Society, the RMOW, and any other appropriate stakeholders.

RELATIONSHIPS WITH OR SUPPORT FOR COMMUNITY ORGANIZATIONS

It is very important for our company to be involved in the communities we operate. In Whistler, we have already committed to the following partnerships with community organizations:

Whistler Community Services Society (WCSS)

Our office has communicated with Dave Clark, Director of Fundraising and Community Engagement with the WCSS, multiple times since May 2022. Most recently, Dave was able to introduce us to their team, providing a tour of their facility including the administration offices, the thrift store, and the food bank. It was impressive to see all the supportive programs that are offered to those in need in Whistler. The more conversations we have with other individuals and associations in Whistler, the more we hear of the great work being done at the WCSS and the impact it has. We were thrilled to be able to commit to becoming Blue Sponsors donating \$5,000 annually to the organization should we be successful in opening a store in the RMOW. We look forward to building this relationship and finding additional ways we can support WCSS in the future.

Should certain conditions be met, we will also distribute 1% of our top line revenues from our Whistler operation on an annual basis to WCSS which we predict based on our current operating locations to be approximately \$50,000 per year. Reference of this undertaking and these conditions can be found in Appendix D.

The Association of Whistler Area Residents for the Environment (AWARE)

Our teams have been communicating with staff at AWARE and are thrilled to be able to offer \$1,000 annually to the organization. This is a very busy organization, and they are integral to the health and longevity of the resort through their programs, education, planning and consulting that they do year-round. We are happy to support the well being of our community and environment in Whistler with this annual donation and look forward to finding other ways our store and operation can support their direction and initiatives in coordination with the *Zero Waste Action Plan* and *Whistler's Climate Action Big Moves Strategy*.

Whistler Offroad Cycling Association (WORCA)

We have had the pleasure of meeting with Trevor Ferrao, Executive Director of WORCA. The trails in Whistler are constantly enjoyed by ourselves, permanent residents, and visitors and we understand it is no easy undertaking keeping these trails maintained. We are happy to commit to becoming Silver level sponsors with WORCA donating \$1,000 annually to be used at their discretion where they need it most, and to provide boots on the ground volunteering throughout the year.

Whistler Chamber of Commerce

We know the value in being involved in the business community we are operating in. In anticipation of approval in the RMOW we proactively joined the Whistler Chamber of Commerce. It has been a pleasure meeting with Louise Walker, Chris Maloney, Jacquie McLean and other team members at the Chamber, in addition to networking and attending events with other members in the community including Power Lunches and Chamber Apres. We look forward to continued involvement with the Chamber.

BALANCING RESORT AND COMMUNITY NEEDS

Our location at 201-4293 Mountain Square in The Village provides excellent geographic equity for both residents and visitors. Because this location does not have any public parking access directly outside the store, it encourages residents and visitors to utilize alternative measures of transportation to shop including walking, biking or taking public transit with bus stops within 200m.

PROVISIONS FOR EMPLOYEE HOUSING

We have had the pleasure of speaking with Program Coordinators at the WHA to better understand the landscape and issues permanent resident workers have finding reasonably priced accommodation in the RMOW. Our company is committed to purchasing property in Whistler pending our approval and utilize this property to help house our staff. We will calculate the rates we charge our tenants in the same way the WHA does despite these properties not being part of their Employee Housing Ownership Program.

"WHA rental rates are based on 30% of the applicant's gross annual household income (with minimum and maximum rental rates for each property)."

We will also commit to installing an electric charger where possible through ChargePoint to incentivize and support our tenants to drive electric vehicles and reduce GHG emissions as part of *Whistler's Climate Action Big Moves Strategy*.

In addition to this, please reference Appendix D. This is a Letter of Undertaking that we have committed ourselves to with our lawyers which stipulates 1% of top line revenue annually that will be utilized to subsidize the housing expenses for our employees should certain conditions be met. This is expected to be approximately \$50,000 to be shared between our employees and will go a long way in securing an affordable living situation for them.

COMMITMENT TO A LIVING WAGE

Costs of living have increased dramatically across Canada. This is especially true in the RMOW where finding a home to rent at a reasonable rate is more difficult.

Our company will commit to a minimum starting wage of \$20 per hour, in line with Vail Resorts. This \$20 per hour will increase quickly to \$22 per hour upon completion of a three-month probation period and interest in more senior training and responsibility with our company. We will also follow any changes made by Vail resorts in the future for their staff and implement them accordingly with ours.

LEADERSHIP ON SUSTAINABILITY AND CLIMATE ACTION

Whistler thrives on mountain culture and the nature that surrounds it so it is imperative that the forests, lakes, rivers, and all that they sustain, are protected. As a business operating in this community, it is important that we do our part in protecting this environment.

Whistler's Climate Action Big Moves Strategy

As a retail business we will be able to execute on various mitigation efforts as set out in the Big Moves Strategy that was adopted by council on December 15, 2020. Specifically, our company can help with moving beyond the car and closing the loop shifting toward lower carbon consumption.

"Personal vehicles are Whistler's largest source of GHG emissions, accounting for 54% of Whistler's total emissions in 2019"

As a company, we will incentivize and promote all our staff to move beyond car-based transport to active transport and increased transit use. Given our store is directly in Whistler Village, there is great access from bus routes from all around the greater Whistler area and we are within walking distance from most visitor lodging.

All deliveries made by our company in accordance with provincial laws will be completed with the use of an E-bike or by walking.

As previously mentioned, our company is also committing to purchase property in Whistler pending approval of our application and will commit to installing a ChargePoint home charger to support the use of EV vehicles by our staff when renting the property.

Zero Waste Action Plan

"The conservation of all resources by means of responsible production, consumption, reuse, and recovery of products, packaging, and materials without burning and with no discharges to land, water, or air that threaten the environment or human health"

Commercial and Strata made up 72.4% of landfill waste in 2020. We are happy to report that all of our locations have utilized a recycling program through EcoAction Recycling since 2021. They provide a recycling solution specific to the Cannabis Retail Industry. The solution provides retailers and customers with an easy way to recycle their cannabis packaging in-store and ensure all packaging rotates through a Circular Economy. It is a great way to show our customers we are helping protect the planet and by choosing us, they are too.

STORE DESIGN

Exterior

The exterior of our stores are always minimalist to not attract attention. Windows are frosted so sensitive demographics can not see products inside. In The Village we chose a lease space off of and out of site from the village stroll however in an area that is still easily accessible by all pedestrians. Renderings of what the exterior of our store will look like can be seen in Appendix A.

Interior

All our This Is Cannabis locations have the same design aesthetic and use the same finishing materials for flooring, millwork, menu boards, display cases and ceilings. That said, there is always an exception when building a store in a municipality as unique as Whistler. Elements of the resort will be incorporated into the final design work to reinforce Whistler's mountain community character. As previously stated, we will also utilize artwork commissioned through the Skwxwú7mesh and Lílwat7úl peoples in coordination with the SLCC. A rendering of the interior of our Whistler store can be seen in Appendix B.

SECURITY PLANNING

Physical Security Assessment (PSA) and Crime Through Environmental Design (CPTED)

Our office has completed a Physical Security Assessment of our specific store location including the security features we will be installing and the impacts we will have on our neighbours and sensitive demographics. We performed this assessment despite it not being a requirement of Cannabis Retail Policy G-27 to illustrate to the RMOW of our commitment to meeting and exceeding Provincial cannabis legislation governing physical security requirements.

These assessments are founded on best practice CPTED principles, industry standard references such as the ASIS General Security Risk Assessment (GSRA) Guideline, best practices, acquired knowledge, and the assessor's professional experience regarding physical security requirements and target hardening of their retail stores. This is Cannabis is committed to demonstrating sound retail practices supporting the Whistler Official Community Plan (OCP) policy framework including upholding the resort experience, while balancing community and guest demand with community safety and a family-friendly environment with focus on:

1. Protecting youth
2. Limiting proliferation
3. Exceeding provincial security requirements to discourage robbery, theft and break and enter

It was concluded that "the owners have committed to implementation of all the recommended security measures as defined in this assessment achieving an industry best practice rating in all scored security mechanisms. This Is Cannabis is and has demonstrated that it is committed to the protection of youth, students, and vulnerable demographics, they have met and exceeded all legislative and ethical requirements in their existing stores. Paladin Risk have audited those existing stores and found that the physical security, staff training, policies and procedures are professional, consistent, and strictly applied. No evidence has been found that their stores have any negative impact on the surrounding youth/sensitive demographics in those areas."

Security Plan

This Is Cannabis has worked closely with the province and Paladin Risk Solutions Inc. to ensure that our security systems in place far exceed what is required for licensed cannabis retail stores in BC. We do not take the safety of customers, employees, deliveries, and inventories lightly in an industry that is still relatively new. At a minimum, the province requires we have the following security measures:

1. An audible intruder alarm system monitored by a third party
2. An audible fire alarm system monitored by a third party
3. Locked retail display cases
4. Locked storage room
5. Secure perimeter door locks
6. Security cameras with full unobstructed view of the retail sales area, any product storage, and the interior and exterior of all entrances and exits
7. Frosted windows to negate visibility into the store from the exterior

In addition to this, we will also utilize the following safety measures specific to this location in Whistler Village:

1. An entrance into our store through a double wide door that allows the delivery of products in just a couple minutes. This allows product to be brought from the delivery truck into our vault, immediately reducing the risk of theft or breakage.
2. Glass break sensors
3. Door contact sensors
4. 360-degree motion sensor cameras in our vault and public retail area
5. Steel bars on all windows
6. Panic buttons at each payment terminal, in our vault, and in the back staff area
7. Signage at entrances and exits indicating age restrictions and use of closed-circuit television (CCTV)

This Is Cannabis locations have all the same security systems installed utilizing the same hardware, software and third-party monitoring. A copy of this security plan can be found in Appendix C.

NUISANCE MITIGATION PLANS

Impact on Visitors and Neighbours Including Odour

Odour control and store ventilation was an important part of our store design in the first two stores we opened in Chilliwack and Abbotsford. These stores are both in busy commercial strip malls with neighbours on both sides of our stores. In three years of operations, we haven't had a single complaint about odours coming from our store. We always consult mechanical engineers in the renovation process to ensure the HVAC systems are adequate and install HEPA air filtration systems to mitigate odours.

This will be no different in the design and construction of our store in Whistler. As per 5.4(r) of our Lease agreement, we have committed to the following:

- 1. The Tenant covenants with the Landlord that no noxious nor strong odours (Cannabis or otherwise) will permeate from the Leased Premises or from the Tenant's activities into other premises or the Common Areas and Common Facilities.*
- 2. The Tenant, at its own cost and expense, will supply and install in the Leased Premises sufficient professional-grade exhaust systems, carbon filter systems, and other installations as recommended in a report (the "HVAC Report") from the Landlord's HVAC consultant (the "HVAC Consultant"), which may include but are not limited to fans, ecologizers, makeup air equipment, and exhaust ducts and louvers that will expediently remove and prevent the spread of any noxious or strong odours from the Leased Premises.*
- 3. The Tenant covenants to abide at its own cost and expense, any requirements and recommendations stated in the HVAC Report and any further recommendations made by the HVAC Consultant or the Landlord, from time to time, with respect to containing and preventing the spread of any noxious or strong odours, failing which the Landlord will have the right to do so on the Tenant's behalf and charge the Tenant for the cost thereof, plus a fifteen (15%) percent administration fee thereon.*

The 3-stage filtration process of a HEPA system is used to create a very effective filtration system. Each filter is independent and can be changed individually.

- Stage 1. Pre-filter - The inexpensive foam pre-filter removes larger particulates from the air, thus prolonging the life of the HEPA filter.*
- Stage 2. HEPA - The HEPA filter removes 99.97% of particulates 0.3 micron and larger. The cleaned air then passes through the third stage filter.*
- Stage 3. Carbon - The carbon filter is about 1/2 an inch thick to give it plenty of surface area for removing chemicals and odors from the air. This filter may be replaced by an optional heavy duty granular carbon canister available for maximum removal of chemicals and odors. The clean air is then reintroduced into the air you breathe.*

Under normal conditions the HEPA filter will last from two to five years however regular service and maintenance of these filters is important to ensure efficient operation. All installation and maintenance should and will be performed by a professional contractor. The installer will be made aware of our indoor air quality and be familiar with our heating, ventilation and air conditioning equipment.

Brochures and specifications on the HEPA air filtration system can be seen in the following documents.

Commitment to Good Neighbour Agreement

In three years of operations at our other two locations in Chilliwack and Abbotsford we have never received a complaint from a neighbour. On the contrary, neighboring businesses appreciate that we are there as we run a professional, respectful business and bring extra foot traffic to the area.

In Whistler, we have written and signed a Good Neighbour Agreement that is a commitment to ensure that business operations are continually monitored to minimize disruption to our neighbours and the Whistler resort experience. Further, Whistler will supply a standard Good Neighbour Agreement on approval, which we proactively commit to executing.

Every effort will be made to:

- Minimize impacts on visitors and neighbours
- Eliminate odours from our operation
- Monitor and direct the Smoking Regulation Bylaw No 2136, 2017 in our immediate area and include educational signage in our store
- Ensure compliance with Storefront design with relevant OCP Development Permit area guidelines, RMOW Sign Bylaw No. 558, 1987 and the CCLA
- Minimize the impacts on sensitive demographics

A copy of this agreement can be found as part of our application.

We also note that our office has already physically visited neighbouring businesses adjacent to our store's proposed location to be transparent about our intentions, offer information about our business, and provide direct contact information should they have any questions or feedback. A copy of the correspondence provided can be seen in Appendix E.

Smoking Regulation Bylaw No. 2136, 2017

Our teams will monitor and direct the Smoking Regulation Bylaw No 2136, 2017 in our immediate area. We will also include educational signage in our store as preferred and as directed by the RMOW.

INDUSTRY AND COMMUNITY SUPPORT LETTERS

Our office has received many support letters to operate a cannabis retail store at this specific location from individuals and businesses that we work with in addition to permanent residents of the Whistler community. These letters speak to the professionalism that we operate our stores with every day and how we are market leaders in customer service and education. Copies of these letters of support can be found in Appendix F.

APPENDIX A – EXTERIOR RENDERING

CANNABIS

THIS
CANNABIS

NOW
OPEN

@thisiscannabiscanada

APPENDIX B – INTERIOR RENDERING



APPENDIX C – SECURITY PLAN

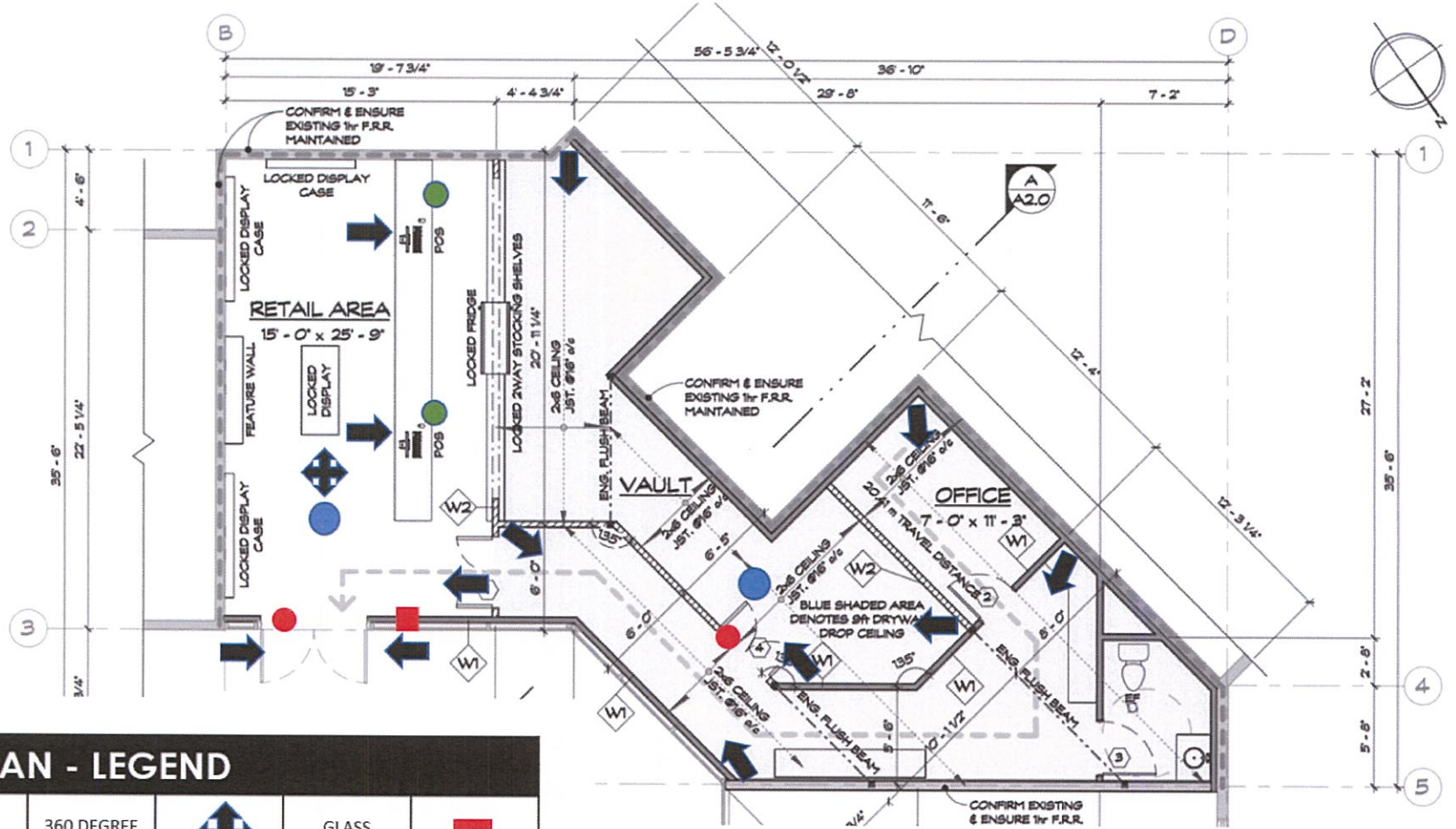

| SECURITY PLAN - LEGEND | | | | | |
|------------------------|--|-------------------|--|--------------|--|
| STATIONARY CAMERA | | 360 DEGREE CAMERA | | GLASS BREAK | |
| 360 DEGREE MOTION | | DOOR CONTACTS | | PANIC BUTTON | |

APPENDIX D – LETTER OF UNDERTAKING

LETTER OF UNDERTAKING

TO: Resort Municipality of Whistler, 4325 Blackcomb Way, Whistler, B.C. V8E 0X5
FROM: 1211633 B.C. Ltd., c/o 201 – 45793 Luckakuck Way, Chilliwack, B.C. V2R 5S3
RE: Approval of RMOW Temporary Use Permit Application for Cannabis Retail (the "Proposal")

WHEREAS:

1211633 B.C. Ltd. (the "Applicant") has submitted the Proposal to the Resort Municipality of Whistler in support of its intention to open and operate a cannabis retail store at premises located at #201A & #201B 4293 Mountain Square, Whistler, BC V0N 1B4 (the "Location").

NOW THEREFORE in consideration of the approval by the Resort Municipality of Whistler (the "Municipality") of the subject Proposal, the Applicant hereby undertakes as follows:

1. Upon commencing operation of the cannabis retail business at the Location, the Applicant will:
 - a. create an annual \$50,000.00 scholarship fund for the benefit of Capilano University (the "Scholarship"); and
 - b. provide an annual distribution as of the anniversary date of the commencement of the Location's operation equal to 2% of the Location's top-line revenue (the "Annual Distribution"), with each such annual distribution projected to be approximately \$100,000.00.
2. For greater certainty, the Scholarship will be available solely to Indigenous persons, with preference given to the Skwxwú7mesh and Lílwat7úl peoples (together, the "Bands").
3. In respect of the Annual Distribution, the Applicant will approach each of the Bands, through their respective community economic development companies being the Skwxwú7mesh Nch'Kay Development Corporation and Lílwat7úl Economic Development Division, to offer each 50% of the Annual Distribution to be used for each band's community and economic development purposes, provided that:
 - a. if, within 60 days, only one Band accepts the offer of the Annual Distribution, then the entire Annual Distribution will be made available to the accepting Band; and
 - b. if, after 60 days, neither Band has accepted the offer of the Annual Distribution, or a portion thereof, the Annual Distribution will instead be divided into two parts, and paid out as follows:
 - i. 50% will be paid to the Whistler Community Services Society for its general community purposes, and
 - ii. 50% will be placed in a fund created by the Applicant to subsidize the housing costs of the Applicant's employees amidst the current housing crisis within the Municipality.

4. For greater certainty, the Applicant will at all times be available and willing to formalize the commitments set forth herein within a more detailed contribution agreement negotiated with the Bands, Whistler Community Services Society, the Municipality, and any other appropriate stakeholders.
5. This Undertaking is a fully binding and enforceable legal obligation of the Applicant, for the benefit of the Municipality.

The undersigned acknowledges that the Municipality is relying upon this Undertaking in approval the Proposal.

Dated as of March 10, 2023.

1211633 B.C. Ltd.

Per:



Cody Les, Director

APPENDIX E – NEIGHBOUR CORRESPONDENCE

THIS

CANNABIS

March 9, 2023

1211633 BC Ltd.
107 - 7670 Vedder Road Chilliwack, BC, V2R 4G9

Attn: Ownership and Management

"THIS IS CANNABIS" is pleased to announce that we have successfully leased Unit #201 – 4293 Mountain Square, Whistler, BC for the purpose of creating Whistler's premier licensed cannabis retail store. We've attached a rendering for what the finished store will look like for your reference.

Our office has consulted with the province's security team to ensure our store has security features that far exceed what would typically be required for this use. We have also consulted with Paladin Risk Solutions to ensure our operation meets and exceeds all criteria for Crime Prevention Through Environmental Design (CPTED), a multi-disciplinary approach to crime reduction utilized to ensure safety and recognized application in overwhelming prevention of criminal activity. In 3 years of operations we have never received an infraction from a municipal, provincial, or federal inspector.

This location in Whistler conforms entirely to the regulations set forth within the regulatory framework issued by the Resort Municipality and our office will be making our application within the application window as defined by the RMOW. In the meantime, we wish to notify you, our neighbor, of our intentions and welcome any feedback you may have. We note that part of our application includes adding a HEPA air filtration HVAC system. Although we do not note any unwanted odours without this system in our other stores (as the products we sell are sealed before being received by our office), we have nonetheless taken this additional step to give further assurance to our neighbors that there will be no detectable odour resulting from our business.

Our This Is Cannabis Whistler location will be our third licensed cannabis retail store in British Columbia, following our successful applications in Chilliwack in 2019 and Abbotsford in 2020. We received unanimous support from city staff and council in Chilliwack and Abbotsford, and great support from our neighbors, including a direct letter of support issued to the City of Chilliwack from Marks Work Wearhouse, our largest anchor neighbor. Neighbours in these developments have also indicated that our presence has noticeably increased sales for their own businesses since we have opened given the traffic we bring in. Recently, several of our neighbors have undergone large-scale renovations, made possible by the increased traffic our stores have created.

As it is important to our firm that we are transparent with our neighbors regarding this endeavour, we wish to make ourselves personally available to you to discuss our cannabis retail store proposal at the above noted address. Please reach out at your convenience using the contact information below if you have any feedback, and the ownership group of our firm will be happy to speak with you privately to discuss the details of this proposed business.

We look forward to making this fantastic addition to Resort Municipality of Whistler and hope to be complimentary neighbors to your business.

Kind Regards,

Ryan Bauer
604-997-9766, ryan@rgnrkventures.com

Cody Les
604-819-1461, cody@rgnrkventures.com

APPENDIX F – SUPPORT LETTERS

Tuesday, February 7, 2023 at 12:22:34 Pacific Standard Time

Subject: Support Whistler
Date: Monday, February 6, 2023 at 4:00:37 PM Pacific Standard Time
From: Dylan King
To: cody@rgnrkventures.com
Attachments: DylanSig.png, ig3.jpg, ig.jpg, ig2.jpg

To: The Resort Municipality of Whistler,

I have known Cody and Ryan from, "This Is Cannabis" for over 2 years. From what I have seen with these guys, it's really remarkable. Watching them build their businesses in small community's and hiring local staff. In my opinion, building one of the top cannabis retailer's in this province. I own a cannabis brand thats known nation wide and "This is cannabis" is consecutivly in the top 10 of all retail stores in BC.

Any community that has these guys opening up any business in their community, is very lucky!. I fully support "This is Cannabis's" proposal.

Thank You,

Dylan King | CEO | Founder
Pistol and Paris™
(604)-897-7117
www.pistolandparis.com

IP | PISTOL AND PARIS™

Dylan King
LEGACY TO LEGAL™



Tuesday, February 7, 2023 at 12:24:40 Pacific Standard Time

Subject: Re: TOL Project 10-32-0071 - Letter of Support
Date: Monday, February 6, 2023 at 2:54:31 PM Pacific Standard Time
From: Matthew Rogers
To: cody@rgnrkventures.com
CC: Ryan Bauer

Good afternoon,
To whom it may concern,

My name is Matthew, I am a customer of This is Cannabis and I would love to support them in their application for a retail location in the Resort Municipality of Whistler.

This Is Cannabis is a fantastic retailer, Every time I walk into their current locations I always feel so welcomed and looked after. The staff and management are always attentive and knowledgeable about my requirements and make sure that I get exactly what I need for my day. The staff are all very well trained and experienced and I always get a level of service at "This is Cannabis" that I dont get anywhere else.

I would really love to see "This is Cannabis" bring a new location to Whistler and support them when they open with my business. Everyone that I recommend "This is Cannabis" always appreciates and mentions that their store is now their "Go-To" location for their Cannabis needs. The management, staff and products are all at the leading edge of the forefront of the industry and I would really like to see them succeed with this application

Please give me a call on 236-512-9922 if you require any further evidence of what great people work at "This is Cannabis"

Best regards,

 **Northern Thrive**

Matt Rogers
Regional Sales
NorthernThrive

 [1 236 512 9922](tel:12365129922)
 matt@northernthrive.ca
 www.northernthrive.ca



Subject: This Is Cannabis Whistler
Date: Wednesday, February 15, 2023 at 9:05:55 AM Pacific Standard Time
From: Antonio Tiergarten
To: cody@rgnrkventures.com, ryan@rgnrkventures.com
Attachments: Outlook-A picture .png, Outlook-A picture .png, Outlook-cidimage00.png, Outlook-cidimage00.png, Outlook-A close up.png

To whom it may concern:

I am a Regional Sales Manager for Rubicon Organics, a cannabis licensed producer based out of Vancouver, BC, and work directly with many cannabis retail stores across British Columbia and Canada. I'm writing in support of bringing This Is Cannabis to The Resort Municipality of Whistler.

This Is Cannabis has the professionalism and service you would want to provide to your residents and visitors. I have been working closely with their ownership and staff team since their first location opened in Chilliwack and can assure you that they are one of the most professional, respectful, and positive cannabis stores to their customers, employees, and fellow industry professionals.

I am confident that The Resort Municipality of Whistler and their residents would only benefit from having This Is Cannabis. Please feel free to contact me with any further questions.

Sincerely,
Antonio Tiergarten



TSXV: ROMJ | OTCQX: ROMJF

Antonio Tiergarten

Regional Sales Manager

M: +1 778-302-8799

A: 505-744 West Hastings Street, Vancouver, BC, V6C 1A5

W: RubiconOrganics.com



Subject: RE: Support Letter - TOL Project 10-32-0071
Date: Tuesday, February 7, 2023 at 3:34:14 PM Pacific Standard Time
From: Joshua Colquhoun
To: cody@rgnrkventures.com
CC: Ryan Bauer
Attachments: image001.png

Gents,

Please see below.

Best,

Josh

.....
Dear The Resort Municipality of Whistler,

My name is Joshua Colquhoun and I work with a large cannabis agency that operates nationwide. The purpose of this letter is to give my support for the proposal of a potential new cannabis storefront within The Resort Municipality of Whistler – **This Is Cannabis**.

The ownership group behind **This Is Cannabis** are some of most professional and community-forward people I have come across in my 4 years of being in this new industry. They are GVRD local owners who have poured thousands of hours of sweat equity into their business.

I have seen the team at **This Is Cannabis** open both their locations in Chilliwack and Abbotsford with tremendous community support. They continue to serve their communities with kind, supportive staff and offer everyone an education-first atmosphere. I have witnessed over 400 store openings. The atmosphere **This Is Cannabis** offers is what a new store in The Resort Municipality of Whistler needs.

As a frequent visitor of Whistler during all seasons of the year, I hope to see a **This Is Cannabis** soon. This municipality deserves to have operators who put people and community first.

Please do not hesitate to reach out if you would like to ask me any questions. Thank you.

Sincerely,

Joshua Colquhoun

Subject: Re: Support Request - WHISTLER

Date: Monday, February 6, 2023 at 2:18:26 PM Pacific Standard Time

From: Jason Lang

To: cody@rgnrkventures.com

CC: Ryan Bauer

Hey Fellas,

Happy to support, please see below.

To whom it may concern,

My name is Jason Lang, and I'm writing to express my support for the proposal to bring This Is Cannabis to the Resort Municipality of Whistler. I have over a decade of experience working in highly regulated consumer packaged goods markets, in both business development and commercialization, and have managed the business for several leading Canadian Cannabis brands in BC (2019-Present).

As a result, I have visited over 400 licensed dispensaries in BC, and personally know hundreds of dispensary owners, managers, and frontline staff. I can say unequivocally that the ownership group, and staff, at This Is Cannabis rank amongst the absolute best.

Ryan, Cody and team are dedicated, industry professionals and have set the gold standard for customer experience, store design, and product assortment. The staff at This Is Cannabis exemplify the highest degree of professionalism, are leaders in cannabis education, and provide a welcoming and safe environment for Cannabis consumers.

I encourage you to allow This Is Cannabis to service the Township of Langley and have the utmost confidence that if given the opportunity, they will make a positive and lasting addition to the community.

Regards,

Jason Lang

On Mon, Feb 6, 2023 at 10:00 AM cody@rgnrkventures.com <cody@rgnrkventures.com> wrote:

Good Morning Jason,

Subject: The Resort Municipality of Whistler
Date: Friday, February 10, 2023 at 10:10:52 AM Pacific Standard Time
From: Danielle Samson
To: cody@rgnrkventures.com
Attachments: image001.jpg

Hello,

I am writing to you to show my support to Cody and Ryan and This Is Cannabis.

I had the pleasure of meeting them both when they first started in the industry and watched them build 2 beautiful, approachable cannabis stores that have become standing examples in the cannabis retail space. This Is Cannabis has continued to grow to become a top performer in the lower mainland and we all would love to see them continue to build that momentum! They employ amazing staff who are always educating themselves and they all are truly passionate about the plant and helping consumers.

I am very confident that they will bring their passion and strong attention to detail to their next location at The Resort Municipality of Whistler. As someone who grew up spending a lot of time in and riding Whistler (my aunt has had her place at the Vale since the early 80's) I can assure you that they will be a perfect fit. Not only do they both have a love for the outdoors, they have also built a strong community based on customer service and education and I have no doubt will succeed in their next project.

Please reach out if you need anything else. Happy to support these guys any way that is needed!

Thanks,

Danielle Samson
Regional Sales Manager | BC
On unceded Musqueam, Squamish and Tsleil-Waututh Territory
phone: 778-865-3233
site: <https://wyldcanna.com/the-why-in-wyld>
email: dsamson@wyldcanna.ca

-
Assets -
<https://brandfolder.com/wyld/canada>
Click the I have a guest password
Enter guest password wyld420



Subject: Support for a This is Cannabis in the Resort Municipality of Whistler
Date: Wednesday, February 8, 2023 at 8:59:03 AM Pacific Standard Time
From: Christian, Aubrecht
To: 'cody Les'
CC: ryan@rgnrkventures.com
Attachments: image001.png, ThisCannabis_WhistlerStore_rev04.jpg

Good morning to whomever this may concern,

My name is Christian Aubrecht and I am a resident of Maple Ridge, BC and a Territory Manager in the Cannabis Industry. I am in full support of the new This is Cannabis location in the Resort Municipality of Whistler. Cody and Ryan have been market leaders in the cannabis industry and rightly so! Their two shops in Abbotsford and Chilliwack are very well run and the staff are always extremely helpful and full of knowledge about the products I am looking to try. Not only are the staff extremely knowledgeable about cannabis, they are also incredibly kind and make the experience a pleasurable one. This is Cannabis is a stand out store from the rest with how professionally run it is. The team is always easy to work with and you can tell that they care about the community they are serving. I have only ever had amazing experiences with staff, management, and ownership at This is Cannabis and I whole heartedly support their growth in every way. I know that having a new This is Cannabis in the Resort Municipality of Whistler will only better the community even further.

I hope to see the new This is Cannabis location approved this year and look forward to having another amazing cannabis shop.

I fully support having a new This is Cannabis location in the Resort Municipality of Whistler.

Thank you,

Christian Aubrecht



MANAGEMENT INC.

CHRISTIAN AUBRECHT
Vancouver Territory Manager
caubrecht@velvetmgmt.com
C 236-668-1057
velvetmanagement.com

Subject: Letter of support for : The Resort Municipality of Whistler
Date: Thursday, February 9, 2023 at 2:04:53 PM Pacific Standard Time
From: Adolfo Gonzalez
To: cody@rgnrkventures.com

To whom this may concern,

My name is Adolfo Gonzalez and though I am not a resident of Whistler I am your neighbor as I live in Burnaby and visit Whistler regularly because I have friends there.

More importantly I have dedicated a good part of my career to working with DTES community members in reducing opiate overdoses using cannabis as a substitute in early stage research efforts into this subject matter. Here is a link to my 2013 publication (<https://www.slideshare.net/AdolfoGonzalez50/reductioninmethadonelettersize>) which is in effect the first peer reviewed opiate substitution study ever conducted in Canada using cannabis.

Since then, there has been enormous gains in this field and I recommend that council considers that we are at the peak of an opiate epidemic, and that the presence of cannabis in our communities likely reduces the need for people to rely on other types of drugs that are much more damaging.

I can tell you with all assurance that your community is still heavily underserved in regard to their access to legal cannabis. Whistler is a big place and there just aren't enough shops for the amount of space/people who live there. It is key to remember that any community needs convenient and diverse points of access for cannabis, just as you would for any other essential goods specially considering the

The result of making the choice to let more legal players into your community will be nothing but positive. The legacy market is slowly dwindling, and cannabis is far too deeply culturally ingrained into our local culture to not be allowed to flourish as the market allows.

I can tell you that my experience with the team at This Is Cannabis has left me inspired enough to write you this letter which comes from the heart. Normalizing cannabis use reduces alcohol and opiate dependence. That is a fact. And companies like these are normalization forces that you must allow, because we need to fight this thing from all sides.

Thanks for reading and I hope you decide to give these kind folks a swing at the plate!

Best regards,



Adolfo Gonzalez | Brand Ambassador, Account Manager
Sensi Brands Inc.
66 Leek Crescent, Unit 4, Richmond Hill ON, L4B 1H1
p: 778-735-2119 m: 604-499-2808 e: adolfo@sensibrands.ca
sensibrands.ca | medmc.ca | sensimed.ca

From: cody@rgnrkventures.com <cody@rgnrkventures.com>
Sent: February 8, 2023 11:22 AM
To: Adolfo Gonzalez <adolfo@sensibrands.ca>
Subject: Re: Letter of support for : TOL Project 10-32-0071

February 7th, 2023

To Resort Municipality of Whistler,

RE: Support for cannabis retail license application for “This is Cannabis”

I am writing to you on behalf of Pure Sunfarms, one of Canada’s top producers of legal cannabis to the recreational market, to support This is Cannabis’ retail application to the Resort Municipality of Whistler.

Collectively, we all have a responsibility to the communities we serve to provide them with access to safe, regulated cannabis product. The alternative is leading constituents to turn, knowingly or not, to illicit sources right in their own backyards, such as entrenched dealers and the many illicit shops that pop up on a simple Google search in your municipality.

What we have learned over the past four years of cannabis legalization is that the number one thing we can all do to combat the illicit market is to get rid of municipal retail deserts and open up access across British Columbia to legal retailers. Establishing this equitable access to regulated storefronts effectively gets unsafe/untested product off the streets and out of the hands of youth¹. And importantly, it stops funding sophisticated criminal operations in the region.

“My message to people who choose to consume cannabis is simple: buy from legal sellers whose regulated product is subject to national requirements that are in place to protect you. In addition to the potential health risks, if you buy illegal cannabis, you could also be supporting organized criminal operations that pose a danger to our communities.”

~ Mike Farnworth, Minister of Public Safety and Solicitor General

While we recognize many municipalities initially elected to opt out of approving cannabis retail licenses because of the perceived threat of increased youth consumption in their communities, almost four years after legalization, it has become apparent that this concern was groundless. In 2020, Statistics Canada found that the number of youth consuming cannabis after legalization has not increased². In fact, the data implied that the initial age onset for cannabis use amongst youth was somewhat delayed. This tells us that the regulatory framework put in place to legalize, strictly regulate and restrict access to cannabis to protect youth is currently working effectively.

In January 2022, 60% of adults in the Metro Vancouver area did not have access to regulated cannabis retailers³. Individuals underserved by regulated cannabis (i.e. living in retail deserts) are not taking the time to drive to neighbouring municipalities to access a safe supply, but rather are choosing convenience over safety.

¹ Testing finds contaminants in illegal cannabis | BC Gov News

² Canadian Cannabis Survey 2020: Summary - Canada.ca

³ BC Chamber of Commerce calls on province to address municipal “cannabis deserts” - StratCann

While we are encouraged to see that this year the Resort Municipality of Whistler began accepting and approving retail applications, as one of the largest populated regions in British Columbia, we urge you to please continue to do your part and approve additional cannabis retail licenses in your municipality. We are confident that as an industry, we can then do our part to out-compete illicit operators, by providing safe, regulated cannabis to adult consumers in your community.

Thank you for your consideration,

Julia Cameron

Vice President, Communications & Corporate Affairs Pure Sunfarms Corp



Hello Resort Municipality of Whistler,

I am writing to you to show my support for a proposed retail store: This Is Cannabis.

I have been working in the Cannabis industry for over 2 years, and I have known Cody since the beginning of my time in this industry. "This Is Cannabis" is an excellent retail store with locations in both Abbotsford and Chilliwack. Both locations exhibit professional staff, a clean and inviting atmosphere, and an excellent selection of high quality products. I 100% attribute these qualities to the leadership provided by Cody and the rest of the management team.

"This Is Cannabis" is a perfect example of how professional, legalized cannabis retail stores can continue to decrease the use of unregulated, black market cannabis while providing a clean and safe environment for legalized cannabis education. As someone who personally resides in the Sea to Sky Corridor, and frequently visits Whistler for a variety of activities and events year round, I have no doubt that a "This Is Cannabis" location in Whistler will be an asset to the community.

Feel free to contact me if you have any further inquiries regarding my opinion on "This Is Cannabis", and their proposed retail store in Whistler.



Cheers,
Steph



Subject: RE: [EXTERNAL] Re: TOL Project 10-32-0071 / This Is Cannabis Langley

Date: Tuesday, February 14, 2023 at 10:02:58 AM Pacific Standard Time

From: Dariya Stoyanova

To: cody@rgnrkventures.com

CC: ryan

Hi Cody,

I am so sorry for the delayed response. The flu going around got me and I was out last week.

I'm so sorry to hear about Langley, but Whistler is a fantastic call!!!

To whom may I concern,

I am writing to you in regard to "This is Cannabis" application for a new location in The Resort Municipality of Whistler. Here is my previous email fixed up! Let me know if there is anything else I can do! 😊

My name is Dariya Stoyanova, BC Territory Manager with MediPharm Labs.

I have had the pleasure to work with Ryan, Cody and the fantastic team from This is Cannabis for over two years now. Cody and Ryan have always been extremely professional, kind and a pleasure to work with! The staff of both This is Cannabis locations is not only super friendly and personable, but they also have a vast cannabis knowledge, which makes the shopping experience fun and easy.

I also have to mention that they don't have a big staff turnover, which is a great indicator of a well run business in my opinion! I would love to see a This Is Cannabis location in The Resort Municipality of Whistler. I am certain that they will be nothing but a positive contribution to your community.

I hope you have a great rest to your week!

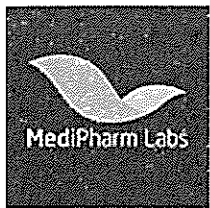

Dariya Stoyanova



Medipharm Labs | Territory Sales Manager



dstoyanova@medipharmlabs.com | p: +1 705-719-7425 | ext. 1535 | m: +1.778.885.68



151 John Street, Barrie, Ontario, Canada L4N 2L1

medipharmlabs.com | TSX : LABS | OTCQX : MEDIF | FSE : MLZ

NOTICE: Information contained in this message is confidential and may be privileged. If you have received this message in error, please notify the sender immediately. You should not copy, rely upon or disclose content of this message to any other party. If you are uncertain about the authenticity of this sender please contact MediPharm via telephone at +1 705.719.7425.

From: cody@rgnrkventures.com <cody@rgnrkventures.com>

Sent: February 6, 2023 10:03 AM

To: Dariya Stoyanova <dstoyanova@medipharmlabs.com>

Cc: Ryan Bauer <ryan@rgnrkventures.com>

Subject: [EXTERNAL] Re: TOL Project 10-32-0071 / This Is Cannabis Langley

[ORIGINATED EXTERNALLY]

Good Morning Dariya!

THIS CANNABIS

Attention: Resort Municipality of Whistler Mayor, Council, and Staff,

Name: Lucy Barnes
Primary Address: 2120 Lake Placid Road
Name of Employer: Earls Whistler

During the week of February 27, 2023, Cody Les and Ryan Bauer visited our business to introduce themselves as the owners of This Is Cannabis (1211633 BC Ltd.), and to provide details regarding their forthcoming application for a new non-medical cannabis retail store located at #201 – 4293 Mountain Square in Whistler Village.

I am in full support of their application, and hope to see their proposed store approved and open in the very near future.

Signature
28.2.23
Date

THIS CANNABIS

Attention: Resort Municipality of Whistler Mayor, Council, and Staff,

Name: Amy McGoldrick
Primary Address: 16-1450 vine road Pemberton, VON 2L1
Name of Employer: Earls Whistler

During the week of February 27, 2023, Cody Les and Ryan Bauer visited our business to introduce themselves as the owners of This Is Cannabis (1211633 BC Ltd.), and to provide details regarding their forthcoming application for a new non-medical cannabis retail store located at #201 – 4293 Mountain Square in Whistler Village.

I am in full support of their application, and hope to see their proposed store approved and open in the very near future.

Amy
Signature

28/2/23
Date

THIS CANNABIS

Attention: Resort Municipality of Whistler Mayor, Council, and Staff,

Name: ANDY TAYLOR.
Primary Address: 8052 TIMBER LANE, WHISTLER.
Name of Employer: EARLS RESTAURANT.

During the week of February 27, 2023, Cody Les and Ryan Bauer visited our business to introduce themselves as the owners of This Is Cannabis (1211633 BC Ltd.), and to provide details regarding their forthcoming application for a new non-medical cannabis retail store located at #201 – 4293 Mountain Square in Whistler Village.

I am in full support of their application, and hope to see their proposed store approved and open in the very near future.



Signature

28/FEB/2023
Date

THIS CANNABIS

Attention: Resort Municipality of Whistler Mayor, Council, and Staff,

Name: Benjamin Dewchar
Primary Address: 2110 Whistler Road
Name of Employer: Earls

During the week of February 27, 2023, Cody Les and Ryan Bauer visited our business to introduce themselves as the owners of This Is Cannabis (1211633 BC Ltd.), and to provide details regarding their forthcoming application for a new non-medical cannabis retail store located at #201 – 4293 Mountain Square in Whistler Village.

I am in full support of their application, and hope to see their proposed store approved and open in the very near future.

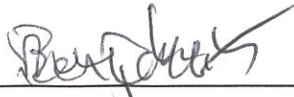
Signature

28/2/23.
Date

THIS CANNABIS

Attention: Resort Municipality of Whistler Mayor, Council, and Staff,

Name: Aidan McMahon
Primary Address: 9436 Deerhorn Drive
Name of Employer: Earls

During the week of February 27, 2023, Cody Les and Ryan Bauer visited our business to introduce themselves as the owners of This Is Cannabis (1211633 BC Ltd.), and to provide details regarding their forthcoming application for a new non-medical cannabis retail store located at #201 – 4293 Mountain Square in Whistler Village.

I am in full support of their application, and hope to see their proposed store approved and open in the very near future.

Signature

02/28/23
Date

THIS CANNABIS

Attention: Resort Municipality of Whistler Mayor, Council, and Staff,

Name: Shaelynn Collins
Primary Address: 34030 Loggers Lane
Name of Employer: The Beacon

During the week of February 27, 2023, Cody Les and Ryan Bauer visited our business to introduce themselves as the owners of This Is Cannabis (1211633 BC Ltd.), and to provide details regarding their forthcoming application for a new non-medical cannabis retail store located at #201 – 4293 Mountain Square in Whistler Village.

I am in full support of their application, and hope to see their proposed store approved and open in the very near future.

Signature

02/28/23
Date

THIS CANNABIS

Attention: Resort Municipality of Whistler Mayor, Council, and Staff,

Name: Alannah Reilly
Primary Address: 6127 Eagle Ridge Drive
Name of Employer: La Brasserie

During the week of February 27, 2023, Cody Les and Ryan Bauer visited our business to introduce themselves as the owners of This Is Cannabis (1211633 BC Ltd.), and to provide details regarding their forthcoming application for a new non-medical cannabis retail store located at #201 – 4293 Mountain Square in Whistler Village.

I am in full support of their application, and hope to see their proposed store approved and open in the very near future.

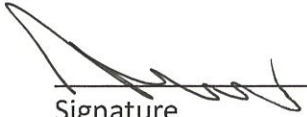
Signature

Feb 28.23
Date

THIS CANNABIS

Attention: Resort Municipality of Whistler Mayor, Council, and Staff,

Name: Pavel Resicek

Primary Address: 8163 Eagle Dr.

Name of Employer: La Brasserie

During the week of February 27, 2023, Cody Les and Ryan Bauer visited our business to introduce themselves as the owners of This Is Cannabis (1211633 BC Ltd.), and to provide details regarding their forthcoming application for a new non-medical cannabis retail store located at #201 – 4293 Mountain Square in Whistler Village.

I am in full support of their application, and hope to see their proposed store approved and open in the very near future.



Signature

1st March 2023
Date

THIS CANNABIS

Attention: Resort Municipality of Whistler Mayor, Council, and Staff,

Name: Hannah Paul
Primary Address: 41746 Honey lane
Name of Employer: La Brasserie

During the week of February 27, 2023, Cody Les and Ryan Bauer visited our business to introduce themselves as the owners of This Is Cannabis (1211633 BC Ltd.), and to provide details regarding their forthcoming application for a new non-medical cannabis retail store located at #201 – 4293 Mountain Square in Whistler Village.

I am in full support of their application, and hope to see their proposed store approved and open in the very near future.

Signature

March 1st 2023
Date

THIS CANNABIS

Attention: Resort Municipality of Whistler Mayor, Council, and Staff,

Name: MITCH MOTOTSUNE
Primary Address: MITCHELLMOTOTSUNE@GMAIL.COM
Name of Employer: THE AMSTERDAM

During the week of February 27, 2023, Cody Les and Ryan Bauer visited our business to introduce themselves as the owners of This Is Cannabis (1211633 BC Ltd.), and to provide details regarding their forthcoming application for a new non-medical cannabis retail store located at #201 – 4293 Mountain Square in Whistler Village.

I am in full support of their application, and hope to see their proposed store approved and open in the very near future.



Signature

03 01 2023

Date

THIS CANNABIS

Attention: Resort Municipality of Whistler Mayor, Council, and Staff,

Name: MITCH KERR
Primary Address: 6159 EAGLE DR
Name of Employer: EL FURNITURE WAREHOUSE

During the week of February 27, 2023, Cody Les and Ryan Bauer visited our business to introduce themselves as the owners of This Is Cannabis (1211633 BC Ltd.), and to provide details regarding their forthcoming application for a new non-medical cannabis retail store located at #201 – 4293 Mountain Square in Whistler Village.

I am in full support of their application, and hope to see their proposed store approved and open in the very near future.



Signature
03/01/23

Date

THIS CANNABIS

Attention: Resort Municipality of Whistler Mayor, Council, and Staff,

Name: GRACE WATSON
Primary Address: 2117 HELM PLACE, WHISTLER BC V8E0A6
Name of Employer: AMSTERDAM PUB

During the week of February 27, 2023, Cody Les and Ryan Bauer visited our business to introduce themselves as the owners of This Is Cannabis (1211633 BC Ltd.), and to provide details regarding their forthcoming application for a new non-medical cannabis retail store located at #201 – 4293 Mountain Square in Whistler Village.

I am in full support of their application, and hope to see their proposed store approved and open in the very near future.

Signature

2023/03/01
Date

THIS CANNABIS

Attention: Resort Municipality of Whistler Mayor, Council, and Staff,

Name: Fredrica Dale
Primary Address: 3317-101 Ptarmigan Pl, Whistler V8E0V7
Name of Employer: O+A Restaurants

During the week of February 27, 2023, Cody Les and Ryan Bauer visited our business to introduce themselves as the owners of This Is Cannabis (1211633 BC Ltd.), and to provide details regarding their forthcoming application for a new non-medical cannabis retail store located at #201 – 4293 Mountain Square in Whistler Village.

I am in full support of their application, and hope to see their proposed store approved and open in the very near future.



Signature

1/3/23 23

Date

THIS CANNABIS

Attention: Resort Municipality of Whistler Mayor, Council, and Staff,

Name: Jaimi Botica
Primary Address: 3108 panorama drive
Name of Employer: Beacon Pub & Eatery.

During the week of February 27, 2023, Cody Les and Ryan Bauer visited our business to introduce themselves as the owners of This Is Cannabis (1211633 BC Ltd.), and to provide details regarding their forthcoming application for a new non-medical cannabis retail store located at #201 – 4293 Mountain Square in Whistler Village.

I am in full support of their application, and hope to see their proposed store approved and open in the very near future.

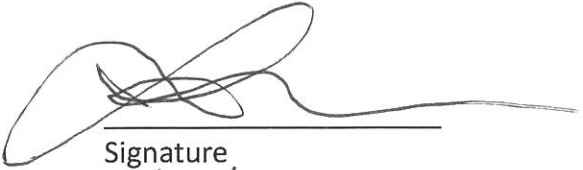

Signature

3/1/23.

Date

THIS CANNABIS

Attention: Resort Municipality of Whistler Mayor, Council, and Staff,

Name: ALESSIA GIARDINELLI

Primary Address: 643 EAGLE DRIVE

Name of Employer: BEACON

During the week of February 27, 2023, Cody Les and Ryan Bauer visited our business to introduce themselves as the owners of This Is Cannabis (1211633 BC Ltd.), and to provide details regarding their forthcoming application for a new non-medical cannabis retail store located at #201 – 4293 Mountain Square in Whistler Village.

I am in full support of their application, and hope to see their proposed store approved and open in the very near future.

Signature

03/01/23
Date

THIS CANNABIS

Attention: Resort Municipality of Whistler Mayor, Council, and Staff,

Name: Amelia Broome
Primary Address: 3523 Sa Lake Road
Name of Employer: Beacon Pub & Eatery

During the week of February 27, 2023, Cody Les and Ryan Bauer visited our business to introduce themselves as the owners of This Is Cannabis (1211633 BC Ltd.), and to provide details regarding their forthcoming application for a new non-medical cannabis retail store located at #201 – 4293 Mountain Square in Whistler Village.

I am in full support of their application, and hope to see their proposed store approved and open in the very near future.

Alabron
Signature

1/03/23
Date

THIS CANNABIS

Attention: Resort Municipality of Whistler Mayor, Council, and Staff,

Name: Emma Gamble
Primary Address: 9261 Pintree Lane Whistler BC
Name of Employer: Tapleys

During the week of February 27, 2023, Cody Les and Ryan Bauer visited our business to introduce themselves as the owners of This Is Cannabis (1211633 BC Ltd.), and to provide details regarding their forthcoming application for a new non-medical cannabis retail store located at #201 – 4293 Mountain Square in Whistler Village.

I am in full support of their application, and hope to see their proposed store approved and open in the very near future.

Signature

March 1/23
Date

THIS CANNABIS

Attention: Resort Municipality of Whistler Mayor, Council, and Staff,

Name: FRANCES DEMONTIGNY
Primary Address: 6834 BARNFIELD PLACE
Name of Employer: BEACON

During the week of February 27, 2023, Cody Les and Ryan Bauer visited our business to introduce themselves as the owners of This Is Cannabis (1211633 BC Ltd.), and to provide details regarding their forthcoming application for a new non-medical cannabis retail store located at #201 – 4293 Mountain Square in Whistler Village.

I am in full support of their application, and hope to see their proposed store approved and open in the very near future.



Signature

MARCH 1, 2023

Date

THIS CANNABIS

Attention: Resort Municipality of Whistler Mayor, Council, and Staff,

Name: Sean Byrne
Primary Address: ~~8497~~ 8497 Matterhorn Drive
Name of Employer: Beacon Pub & Eatery

During the week of February 27, 2023, Cody Les and Ryan Bauer visited our business to introduce themselves as the owners of This Is Cannabis (1211633 BC Ltd.), and to provide details regarding their forthcoming application for a new non-medical cannabis retail store located at #201 – 4293 Mountain Square in Whistler Village.

I am in full support of their application, and hope to see their proposed store approved and open in the very near future.

Sean Byrne
Signature

March 1st 2023
Date

THIS CANNABIS

Attention: Resort Municipality of Whistler Mayor, Council, and Staff,

Name:

Cody Les

Primary Address:

7033 Nesters Rd

Name of Employer:

Beacon

During the week of February 27, 2023, Cody Les and Ryan Bauer visited our business to introduce themselves as the owners of This Is Cannabis (1211633 BC Ltd.), and to provide details regarding their forthcoming application for a new non-medical cannabis retail store located at #201 – 4293 Mountain Square in Whistler Village.

I am in full support of their application, and hope to see their proposed store approved and open in the very near future.

[Signature]

Signature

1/3/23

Date

THIS CANNABIS

Attention: Resort Municipality of Whistler Mayor, Council, and Staff,

Name: NICOLE WILSON
Primary Address: 9432 DEERHORN PLACE
Name of Employer: TAPLEY'S PUB

During the week of February 27, 2023, Cody Les and Ryan Bauer visited our business to introduce themselves as the owners of This Is Cannabis (1211633 BC Ltd.), and to provide details regarding their forthcoming application for a new non-medical cannabis retail store located at #201 – 4293 Mountain Square in Whistler Village.

I am in full support of their application, and hope to see their proposed store approved and open in the very near future.

NW

Signature

MARCH 1st 2023

Date

THIS CANNABIS

Attention: Resort Municipality of Whistler Mayor, Council, and Staff,

Name: Stacey Port
Primary Address: 2216 Lake Placid Road, Whistler
Name of Employer: Lorghorn

During the week of February 27, 2023, Cody Les and Ryan Bauer visited our business to introduce themselves as the owners of This Is Cannabis (1211633 BC Ltd.), and to provide details regarding their forthcoming application for a new non-medical cannabis retail store located at #201 – 4293 Mountain Square in Whistler Village.

I am in full support of their application, and hope to see their proposed store approved and open in the very near future.

S. Port
Signature

1st March 2023
Date

THIS CANNABIS

Attention: Resort Municipality of Whistler Mayor, Council, and Staff,

Name: Nathan Tomarchio
Primary Address: 2168 Kathleen place
Name of Employer: Longhorns

During the week of February 27, 2023, Cody Les and Ryan Bauer visited our business to introduce themselves as the owners of This Is Cannabis (1211633 BC Ltd.), and to provide details regarding their forthcoming application for a new non-medical cannabis retail store located at #201 – 4293 Mountain Square in Whistler Village.

I am in full support of their application, and hope to see their proposed store approved and open in the very near future.

Signature

3/1/23
Date

THIS CANNABIS

Attention: Resort Municipality of Whistler Mayor, Council, and Staff,

Name: Jennifer Felt
Primary Address: 8329 Arden Drive
Name of Employer: Longhorn Tavern

During the week of February 27, 2023, Cody Les and Ryan Bauer visited our business to introduce themselves as the owners of This Is Cannabis (1211633 BC Ltd.), and to provide details regarding their forthcoming application for a new non-medical cannabis retail store located at #201 – 4293 Mountain Square in Whistler Village.

I am in full support of their application, and hope to see their proposed store approved and open in the very near future.

 Jennifer Felt
Signature

 11/26/23
Date

THIS CANNABIS

Attention: Resort Municipality of Whistler Mayor, Council, and Staff,

Name: Gaull Cote - Boily
Primary Address: 26-22M Harcourt place
Name of Employer: Gibbons

During the week of February 27, 2023, Cody Les and Ryan Bauer visited our business to introduce themselves as the owners of This Is Cannabis (1211633 BC Ltd.), and to provide details regarding their forthcoming application for a new non-medical cannabis retail store located at #201 – 4293 Mountain Square in Whistler Village.

I am in full support of their application, and hope to see their proposed store approved and open in the very near future.

Signature

01/03/2023
Date

THIS CANNABIS

Attention: Resort Municipality of Whistler Mayor, Council, and Staff,

Name: Ellie Matthews
Primary Address: 319 Panorama Ridge, Whistler
Name of Employer: Longhorn Saloon

During the week of February 27, 2023, Cody Les and Ryan Bauer visited our business to introduce themselves as the owners of This Is Cannabis (1211633 BC Ltd.), and to provide details regarding their forthcoming application for a new non-medical cannabis retail store located at #201 – 4293 Mountain Square in Whistler Village.

I am in full support of their application, and hope to see their proposed store approved and open in the very near future.



Signature

1/03/23
Date

THIS CANNABIS

Attention: Resort Municipality of Whistler Mayor, Council, and Staff,

Name: Dennis Gagné
Primary Address: 2144 Lake Placid rd.
Name of Employer: Black Tie Ski Rentals

During the week of February 27, 2023, Cody Les and Ryan Bauer visited our business to introduce themselves as the owners of This Is Cannabis (1211633 BC Ltd.), and to provide details regarding their forthcoming application for a new non-medical cannabis retail store located at #201 – 4293 Mountain Square in Whistler Village.

I am in full support of their application, and hope to see their proposed store approved and open in the very near future.



Signature

1/3/23

Date

THIS CANNABIS

Attention: Resort Municipality of Whistler Mayor, Council, and Staff,

Name: Molly Phillips
Primary Address: 6447 Balsam Way, Whistler
Name of Employer: Longhorn Saloon

During the week of February 27, 2023, Cody Les and Ryan Bauer visited our business to introduce themselves as the owners of This Is Cannabis (1211633 BC Ltd.), and to provide details regarding their forthcoming application for a new non-medical cannabis retail store located at #201 – 4293 Mountain Square in Whistler Village.

I am in full support of their application, and hope to see their proposed store approved and open in the very near future.

Signature

1/3/23
Date

THIS CANNABIS

Attention: Resort Municipality of Whistler Mayor, Council, and Staff,

Name: Evan Kimoff
Primary Address: 8526 Buckham Dr
Name of Employer: Longhorn

During the week of February 27, 2023, Cody Les and Ryan Bauer visited our business to introduce themselves as the owners of This Is Cannabis (1211633 BC Ltd.), and to provide details regarding their forthcoming application for a new non-medical cannabis retail store located at #201 – 4293 Mountain Square in Whistler Village.

I am in full support of their application, and hope to see their proposed store approved and open in the very near future.

Signature

Date

THIS CANNABIS

Attention: Resort Municipality of Whistler Mayor, Council, and Staff,

Name: Colin Sartor
Primary Address: 5882 Bagley Ave.
Name of Employer: Whistler

During the week of February 27, 2023, Cody Les and Ryan Bauer visited our business to introduce themselves as the owners of This Is Cannabis (1211633 BC Ltd.), and to provide details regarding their forthcoming application for a new non-medical cannabis retail store located at #201 – 4293 Mountain Square in Whistler Village.

I am in full support of their application, and hope to see their proposed store approved and open in the very near future.

Signature

03/01/2023
Date

THIS CANNABIS

Attention: Resort Municipality of Whistler Mayor, Council, and Staff,

Name: Steven Sartor
Primary Address: 1882 Bayberry Ave
Name of Employer: Whistler

During the week of February 27, 2023, Cody Les and Ryan Bauer visited our business to introduce themselves as the owners of This Is Cannabis (1211633 BC Ltd.), and to provide details regarding their forthcoming application for a new non-medical cannabis retail store located at #201 – 4293 Mountain Square in Whistler Village.

I am in full support of their application, and hope to see their proposed store approved and open in the very near future.



Signature

03/01/2023
Date

THIS CANNABIS

Attention: Resort Municipality of Whistler Mayor, Council, and Staff,

Name: Cody Hamilton
Primary Address: 2315 ASPEN CT
Name of Employer: GIBBONS

During the week of February 27, 2023, Cody Les and Ryan Bauer visited our business to introduce themselves as the owners of This Is Cannabis (1211633 BC Ltd.), and to provide details regarding their forthcoming application for a new non-medical cannabis retail store located at #201 – 4293 Mountain Square in Whistler Village.

I am in full support of their application, and hope to see their proposed store approved and open in the very near future.

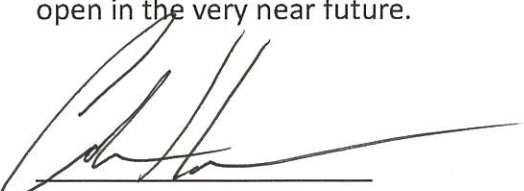

Signature

1/3/23

Date

THIS CANNABIS

Attention: Resort Municipality of Whistler Mayor, Council, and Staff,

Name: Dylan Maccombie
Primary Address: 6447 Balsam Way
Name of Employer: Ziptrek

During the week of February 27, 2023, Cody Les and Ryan Bauer visited our business to introduce themselves as the owners of This Is Cannabis (1211633 BC Ltd.), and to provide details regarding their forthcoming application for a new non-medical cannabis retail store located at #201 – 4293 Mountain Square in Whistler Village.

I am in full support of their application, and hope to see their proposed store approved and open in the very near future.

[Signature]
Signature

1.3.23
Date

THIS CANNABIS

Attention: Resort Municipality of Whistler Mayor, Council, and Staff,

Name: Maddey Kimmerer
Primary Address: 2717 Kimrock Road
Name of Employer: Gibbons

During the week of February 27, 2023, Cody Les and Ryan Bauer visited our business to introduce themselves as the owners of This Is Cannabis (1211633 BC Ltd.), and to provide details regarding their forthcoming application for a new non-medical cannabis retail store located at #201 – 4293 Mountain Square in Whistler Village.

I am in full support of their application, and hope to see their proposed store approved and open in the very near future.



Signature

03/01/2023
Date

THIS CANNABIS

Attention: Resort Municipality of Whistler Mayor, Council, and Staff,

Name: Alysha Gowat
Primary Address: 6533 balsam way, whistler, BC.
Name of Employer: furnies

During the week of February 27, 2023, Cody Les and Ryan Bauer visited our business to introduce themselves as the owners of This Is Cannabis (1211633 BC Ltd.), and to provide details regarding their forthcoming application for a new non-medical cannabis retail store located at #201 – 4293 Mountain Square in Whistler Village.

I am in full support of their application, and hope to see their proposed store approved and open in the very near future.

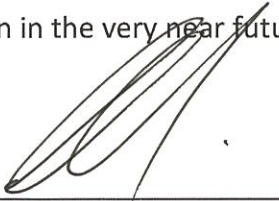

Signature

1/3/2023
Date

THIS CANNABIS

Attention: Resort Municipality of Whistler Mayor, Council, and Staff,

Name: Sammy Lacey
Primary Address: 6567 Balsam Way
Name of Employer: Loughorn

During the week of February 27, 2023, Cody Les and Ryan Bauer visited our business to introduce themselves as the owners of This Is Cannabis (1211633 BC Ltd.), and to provide details regarding their forthcoming application for a new non-medical cannabis retail store located at #201 – 4293 Mountain Square in Whistler Village.

I am in full support of their application, and hope to see their proposed store approved and open in the very near future.

[Signature]
Signature
1/3/23
Date

THIS CANNABIS

Attention: Resort Municipality of Whistler Mayor, Council, and Staff,

Name: Molly Hagen
Primary Address: 72A 2222 Brandywine Way
Name of Employer: Pan Pacific

During the week of February 27, 2023, Cody Les and Ryan Bauer visited our business to introduce themselves as the owners of This Is Cannabis (1211633 BC Ltd.), and to provide details regarding their forthcoming application for a new non-medical cannabis retail store located at #201 – 4293 Mountain Square in Whistler Village.

I am in full support of their application, and hope to see their proposed store approved and open in the very near future.

Signature

03/01/23
Date

THIS CANNABIS

Attention: Resort Municipality of Whistler Mayor, Council, and Staff,

Name: Sharnee Geary
Primary Address: 6104 Eagle drive, Whistler, BC
Name of Employer: George Lambourne

During the week of February 27, 2023, Cody Les and Ryan Bauer visited our business to introduce themselves as the owners of This Is Cannabis (1211633 BC Ltd.), and to provide details regarding their forthcoming application for a new non-medical cannabis retail store located at #201 – 4293 Mountain Square in Whistler Village.

I am in full support of their application, and hope to see their proposed store approved and open in the very near future.

Sgeary
Signature

1/3/2023
Date

THIS CANNABIS

Attention: Resort Municipality of Whistler Mayor, Council, and Staff,

Name: Jordan Pearson
Primary Address: 6533 BALSAM WAY, WHISTLER
Name of Employer: EE FURNITURE WAREHOUSE

During the week of February 27, 2023, Cody Les and Ryan Bauer visited our business to introduce themselves as the owners of This Is Cannabis (1211633 BC Ltd.), and to provide details regarding their forthcoming application for a new non-medical cannabis retail store located at #201 – 4293 Mountain Square in Whistler Village.

I am in full support of their application, and hope to see their proposed store approved and open in the very near future.

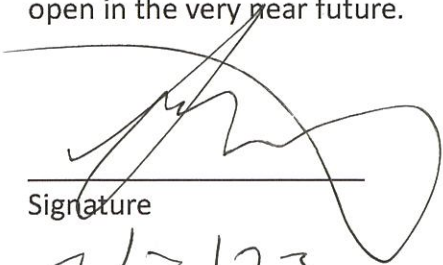

Signature

1/3/23

Date

THIS CANNABIS

Attention: Resort Municipality of Whistler Mayor, Council, and Staff,

Name: George Lambourne
Primary Address: 6569 Bellisan Way
Name of Employer: Tapleys

During the week of February 27, 2023, Cody Les and Ryan Bauer visited our business to introduce themselves as the owners of This Is Cannabis (1211633 BC Ltd.), and to provide details regarding their forthcoming application for a new non-medical cannabis retail store located at #201 – 4293 Mountain Square in Whistler Village.

I am in full support of their application, and hope to see their proposed store approved and open in the very near future.



Signature

1/3/2023

Date

THIS CANNABIS

Attention: Resort Municipality of Whistler Mayor, Council, and Staff,

Name: Julian Scrivo
Primary Address: 7531 Seppos Way
Name of Employer: GLC

During the week of February 27, 2023, Cody Les and Ryan Bauer visited our business to introduce themselves as the owners of This Is Cannabis (1211633 BC Ltd.), and to provide details regarding their forthcoming application for a new non-medical cannabis retail store located at #201 – 4293 Mountain Square in Whistler Village.

I am in full support of their application, and hope to see their proposed store approved and open in the very near future.



Signature

March 1/2023

Date

THIS CANNABIS

Attention: Resort Municipality of Whistler Mayor, Council, and Staff,

Name: GIOVANNI LONG
Primary Address: 7354 TOMI SAILER LN
Name of Employer: WHISTLE

During the week of February 27, 2023, Cody Les and Ryan Bauer visited our business to introduce themselves as the owners of This Is Cannabis (1211633 BC Ltd.), and to provide details regarding their forthcoming application for a new non-medical cannabis retail store located at #201 – 4293 Mountain Square in Whistler Village.

I am in full support of their application, and hope to see their proposed store approved and open in the very near future.



Signature
MAR 1 / 2023

Date

THIS CANNABIS

Attention: Resort Municipality of Whistler Mayor, Council, and Staff,

Name: CHRISTOPHER AMES
Primary Address: 8220 Rainbow Drive
Name of Employer: Sundial Hotel

During the week of February 27, 2023, Cody Les and Ryan Bauer visited our business to introduce themselves as the owners of This Is Cannabis (1211633 BC Ltd.), and to provide details regarding their forthcoming application for a new non-medical cannabis retail store located at #201 – 4293 Mountain Square in Whistler Village.

I am in full support of their application, and hope to see their proposed store approved and open in the very near future.

Signature

1/3/23
Date

THIS CANNABIS

Attention: Resort Municipality of Whistler Mayor, Council, and Staff,

Name: Oscar Raworth
Primary Address: 8329 Chalet Drive
Name of Employer: Whistler Blackcomb Snow School

During the week of February 27, 2023, Cody Les and Ryan Bauer visited our business to introduce themselves as the owners of This Is Cannabis (1211633 BC Ltd.), and to provide details regarding their forthcoming application for a new non-medical cannabis retail store located at #201 – 4293 Mountain Square in Whistler Village.

I am in full support of their application, and hope to see their proposed store approved and open in the very near future.

OR
Signature

01/03/23
Date

THIS CANNABIS

Attention: Resort Municipality of Whistler Mayor, Council, and Staff,

Name: Olve Delland
Primary Address: 6139 Eagle Drive
Name of Employer: Araxi

During the week of February 27, 2023, Cody Les and Ryan Bauer visited our business to introduce themselves as the owners of This Is Cannabis (1211633 BC Ltd.), and to provide details regarding their forthcoming application for a new non-medical cannabis retail store located at #201 – 4293 Mountain Square in Whistler Village.

I am in full support of their application, and hope to see their proposed store approved and open in the very near future.

RO
Signature

1/02/23
Date

THIS CANNABIS

Attention: Resort Municipality of Whistler Mayor, Council, and Staff,

Name:

Coley Bennett

Primary Address:

2110 Whistler Rd

Name of Employer:

Earls

During the week of February 27, 2023, Cody Les and Ryan Bauer visited our business to introduce themselves as the owners of This Is Cannabis (1211633 BC Ltd.), and to provide details regarding their forthcoming application for a new non-medical cannabis retail store located at #201 – 4293 Mountain Square in Whistler Village.

I am in full support of their application, and hope to see their proposed store approved and open in the very near future.

Signature

March 1 / 23
Date

THIS CANNABIS

Attention: Resort Municipality of Whistler Mayor, Council, and Staff,

Name: NIKKI FARRELL
Primary Address: 8544 DRIFTER WAY
Name of Employer: BEACON

During the week of February 27, 2023, Cody Les and Ryan Bauer visited our business to introduce themselves as the owners of This Is Cannabis (1211633 BC Ltd.), and to provide details regarding their forthcoming application for a new non-medical cannabis retail store located at #201 – 4293 Mountain Square in Whistler Village.

I am in full support of their application, and hope to see their proposed store approved and open in the very near future.



Signature

MARCH 1 / 2023
Date

THIS CANNABIS

Attention: Resort Municipality of Whistler Mayor, Council, and Staff,

Name: Sandrine Beaulieu
Primary Address: 28-6125 Eagle Drive
Name of Employer: Sushi Village

During the week of February 27, 2023, Cody Les and Ryan Bauer visited our business to introduce themselves as the owners of This Is Cannabis (1211633 BC Ltd.), and to provide details regarding their forthcoming application for a new non-medical cannabis retail store located at #201 – 4293 Mountain Square in Whistler Village.

I am in full support of their application, and hope to see their proposed store approved and open in the very near future.

Sauol

Signature

March 1st

Date

THIS CANNABIS

Attention: Resort Municipality of Whistler Mayor, Council, and Staff,

Name: Nicholas Theoret
Primary Address: 8139 Alpine Way
Name of Employer: BC Parks

During the week of February 27, 2023, Cody Les and Ryan Bauer visited our business to introduce themselves as the owners of This Is Cannabis (1211633 BC Ltd.), and to provide details regarding their forthcoming application for a new non-medical cannabis retail store located at #201 – 4293 Mountain Square in Whistler Village.

I am in full support of their application, and hope to see their proposed store approved and open in the very near future.

Signature

March 1, 2023
Date

1211633 BC LTD. (DBA THIS IS CANNABIS)

(Company Name)

201A + 201B 4293 MOUNTAIN SQUARE WHISTLER, BC

(Address)

RYAN BAUER 604 997 9776 RYAN@RGNRVENTURES.COM

(Contact Details)

File No. N/A

Date MARCH 11, 2023

Resort Municipality of Whistler
4325 Blackcomb Way
Whistler BC V8E 0X5

Attention: Planning Dept.

Re: **Good Neighbour Agreement** CANNABIS RETAIL STORE TUP APPLICATION POLICY G-77
(project name and address)

This letter confirms the commitment of RYAN BAUER + CODY CES
(name of business owners)

To ensure that business operations are continually monitored to minimize disruption to our neighbours and the Whistler resort experience.

Every effort will be made to:

- Minimize impacts on visitors and neighbours
- Minimize odours from our operation
- Monitor and direct the Smoking Regulation Bylaw No 2136, 2017 in our immediate area and include educational signage in our store
- Ensure compliance with Storefront design with relevant OCP Development Permit area guidelines, RMOW Sign Bylaw No. 558, 1987 and the CCLA
- Minimize the impacts on sensitive demographics

Signed:

Name, Title OWNER

Name, Title OWNER

THIS

CANNABIS

March 9, 2023

1211633 BC Ltd.
107 - 7670 Vedder Road Chilliwack, BC, V2R 4G9

Attn: Ownership and Management

"THIS IS CANNABIS" is pleased to announce that we have successfully leased Unit #201 – 4293 Mountain Square, Whistler, BC for the purpose of creating Whistler's premier licensed cannabis retail store. We've attached a rendering for what the finished store will look like for your reference.

Our office has consulted with the province's security team to ensure our store has security features that far exceed what would typically be required for this use. We have also consulted with Paladin Risk Solutions to ensure our operation meets and exceeds all criteria for Crime Prevention Through Environmental Design (CPTED), a multi-disciplinary approach to crime reduction utilized to ensure safety and recognized application in overwhelming prevention of criminal activity. In 3 years of operations we have never received an infraction from a municipal, provincial, or federal inspector.

This location in Whistler conforms entirely to the regulations set forth within the regulatory framework issued by the Resort Municipality and our office will be making our application within the application window as defined by the RMOW. In the meantime, we wish to notify you, our neighbor, of our intentions and welcome any feedback you may have. We note that part of our application includes adding a HEPA air filtration HVAC system. Although we do not note any unwanted odours without this system in our other stores (as the products we sell are sealed before being received by our office), we have nonetheless taken this additional step to give further assurance to our neighbors that there will be no detectable odour resulting from our business.

Our This Is Cannabis Whistler location will be our third licensed cannabis retail store in British Columbia, following our successful applications in Chilliwack in 2019 and Abbotsford in 2020. We received unanimous support from city staff and council in Chilliwack and Abbotsford, and great support from our neighbors, including a direct letter of support issued to the City of Chilliwack from Marks Work Wearhouse, our largest anchor neighbor. Neighbours in these developments have also indicated that our presence has noticeably increased sales for their own businesses since we have opened given the traffic we bring in. Recently, several of our neighbors have undergone large-scale renovations, made possible by the increased traffic our stores have created.

As it is important to our firm that we are transparent with our neighbors regarding this endeavour, we wish to make ourselves personally available to you to discuss our cannabis retail store proposal at the above noted address. Please reach out at your convenience using the contact information below if you have any feedback, and the ownership group of our firm will be happy to speak with you privately to discuss the details of this proposed business.

We look forward to making this fantastic addition to Resort Municipality of Whistler and hope to be complimentary neighbors to your business.

Kind Regards,

Ryan Bauer
604-997-9766, ryan@rgnrkventures.com

Cody Les
604-819-1461, cody@rgnrkventures.com



THIS

CANNABIS

BUSINESS PLAN

THIS IS COMMUNITY

THIS IS CANNABIS

Contents

- EXECUTIVE SUMMARY** 2
- APPLICANTS BUSINESS EXPERIENCE** 3
- SOCIAL RESPONSIBILITY AND COMMUNITY BENEFIT** 3
 - Bowls of Hope..... 3
 - Abbotsford Community Foundation..... 4
 - Chilliwack Chamber of Commerce..... 4
 - Whistler Chamber of Commerce 4
 - Skwxwú7mesh and Lílwat7úl Nations 4
 - Whistler Community Services Society (WCSS)..... 5
 - The Association of Whistler Area Residents for the Environment (AWARE) 5
 - Whistler Offroad Cycling Association (WORCA) 6
 - Whistler Housing Authority (WHA) 6
- LEADERSHIP ON SUSTAINABILITY AND CLIMATE ACTION** 6
 - Whistler's Climate Action Big Moves Strategy 7
 - Zero Waste Action Plan..... 7
- PRODUCT**..... 7
 - Products Sold..... 7
- SECURITY REPORT AND CRIME PREVENTION THROUGH ENVIRONMENTAL DESIGN (CPTED)** 8
- SECURITY COMPLIANCE** 8
- DESCRIPTION OF OPERATIONS** 9
 - Staffing..... 9
 - Hours of Operation 9
 - Educational Initiatives 9
 - Corporate Structure 10
 - Customers and Target Market 10
 - Sales Record Keeping 11
 - Staff Record Keeping 11
 - Return Policies 11
 - Compliance Procedures 11
- INSURANCE COVERAGE INFORMATION** 12



EXECUTIVE SUMMARY

The former perception of cannabis is over – This Is Cannabis. It is our mission to serve customers with an industry leading shopping experience providing them with a warm, welcoming, and educational environment. As a team, we ensure our business upholds the values and policies consistent with each municipality we are operating. In Whistler, it will be imperative that we become contributing members of the community and ensure we reinforce Whistler's mountain community character, promote community and social well-being, balance community and visitor demand and support economic opportunities with the Skwxwú7mesh and Líl'wat7úl people.

Our founders, Ryan Bauer and Cody Les, have a proven track record of working in coordination with the province and other municipalities in opening provincially licensed cannabis retail stores. This Is Cannabis has been operating in Chilliwack since April 3, 2020 and in Abbotsford since April 3, 2021. Each shop is a market leader in their respective communities building strong relationships and operating with zero infractions.

This location in Whistler Village will be exceptional for serving both permanent residents and guests while ensuring discretion and safety for the community and our neighbours. We are very excited to work with the Resort Municipality of Whistler to ensure a successful operation.

Highlights of this application include but are not limited to:

- **2% of top line revenue** shared annually with the **Skwxwú7mesh Nation** and **Líl'wat7úl Nation** in coordination with their respective community economic development groups being the **Nch'Kay Development Group** and the **Lil'Wat Business Group**, projected to be **\$100,000 annually**.
- **\$50,000 annual bursary with Capilano University** for Indigenous students with preference given to Skwxwú7mesh and Líl'wat7úl people.
- **\$5,000** annual Blue Sponsor with Whistler Community Services Centre (WCSS).
- **\$1,000** annual donation to both the Whistler Off Road Cycling Association (WORCA) and the Association of Whistler Area Residents for the Environment (AWARE).
- **\$450,000** in combined earnings for employees (over \$24/hour average) in addition to wellness and benefits packages.
- **Subsidized housing** for our staff through our own property with rates charged to our tenants using prescribed WHA housing calculations despite these properties not being part of their Employee Housing Ownership Program.

Sincerely,



Ryan Bauer



Cody Les

APPLICANTS BUSINESS EXPERIENCE

Ryan and Cody opened the first This Is Cannabis location in Chilliwack on April 3, 2020. They opened their second location in Abbotsford on April 3, 2021. Since inception, This Is Cannabis has been a market leader in British Columbia in terms of customer experience, education, product variety, volume, and culture and they have had zero contraventions in accordance with provincial and municipal rules and regulations. We understand that cannabis is not a one-size-fits-all approach and have built a team of passionate and educated cannabis consultants who provide customers with a warm, inviting, and informative experience.

Before developing This Is Cannabis, Ryan had 10 years of business development experience in construction and product development. In 2017, Ryan co-founded a company called Dynamix, developing proprietary drink mixes for medical cannabis oil consumption. The beverage decreased the onset time of effects and masked the foul, lingering, tastes and textures of medical cannabis oil. He was responsible for product development, branding, sales and marketing. Dynamix committed to selling through legal channels only, building sales partnerships with legal medical cannabis clinics and licensed producers across Canada. Ryan also holds a Mathematics Major from the University of British Columbia and a Master in Business Administration (MBA) from the Ivey Business School, one of the top business schools in Canada.

Before developing This Is Cannabis, Cody was an experienced residential, industrial, and commercial real estate development manager based out of Chilliwack, BC, responsible for acquisitions, rezoning and land development coordination, provincial and federal licensing, and sub-consultant management pertaining to the civil, environmental, engineering, legal, financing, and design teams. He was most recently contracted by Diverse Properties and Genica Group of Companies to manage large scale real estate operations.

SOCIAL RESPONSIBILITY AND COMMUNITY BENEFIT

It is very important for our company to be involved in the communities we operate in. We are partners with multiple organizations in Chilliwack and Abbotsford and have already committed to partnering with several more in Whistler:

Bowls of Hope

Bowls of Hope is a registered charitable organization that provides local food security programs and initiatives to children and families in Chilliwack and the surrounding areas. We help feed over 900 children every day in the Chilliwack school system through annual capital donations and volunteering efforts. We have been partnered with Bowls of Hope

for over three years and personally *"provide unwavering support and assistance every time they are called upon."*

Abbotsford Community Foundation

We provide an annual scholarship called the "Rise Annual Student Award" which we grant to one student per year within the Abbotsford School District that demonstrates leadership, empathy, and a strong desire to continue education within a field they are passionate to pursue. Successful recipients will be expected to demonstrate their post-secondary action plan, and specific consideration will be given to those who communicate desire to pursue entrepreneurship upon graduation.

Chilliwack Chamber of Commerce

We have been members of the Chilliwack Chamber of Commerce for over three years. Their Executive Director, Leanna Kemp, states *"Ryan and Cody have been great individuals to work with; they are responsive and professional and demonstrate a real passion for our community."*

Whistler Chamber of Commerce

We know the value in being involved in the business community we are operating in. In anticipation of approval in the RMOW we proactively joined the Whistler Chamber of Commerce. It has been a pleasure meeting with Louise Walker, Chris Maloney, Jacquie McLean and other team members at the Chamber, in addition to networking and attending events with other members in the community including Power Lunches and Chamber Apres. We look forward to continued involvement with the Chamber.

Skwxwú7mesh and Lílwat7úl Nations

We acknowledge that the location of our proposed store is on the unceded and shared territory of the Skwxwú7mesh and Lílwat7úl peoples. In submitting this proposal to the Resort Municipality of Whistler, we have made significant efforts to ensure that we have actively engaged with the Nations so as to further reconciliation and economic opportunities, as outlined in the permit requirements set forth in Cannabis Retail Policy G-27.

Following these conversations, we have drafted a Letter of Undertaking (which can be referenced in Appendix A) through our lawyers committing ourselves to the following two initiatives upon commencing operation of the cannabis retail store in Whistler:

1. Create an annual \$50,000 scholarship fund with the Capilano University Foundation made available to Indigenous persons, with preference given to the Skwxwú7mesh and Lílwat7úl peoples, and
2. Provide an annual distribution equal to 2% of the location's yearly top-line revenue, projected to be approximately \$100,000 per year.

With respect to the annual distribution, we will approach each of the Nations through their respective community economic development companies (Skwxwú7mesh

Nch'Kay Development Corporation and Liłwat7úl Economic Development Division), to offer each 50% of the annual distribution to be used for each Nation's community and economic development purposes, provided that:

if, within 60 days, only one Nations accepts the offer of the annual distribution, then the entire annual distribution will be made available to the accepting Band; and

if, after 60 days, neither Nation has accepted the offer of the annual distribution, or a portion thereof, the annual distribution will instead be divided into two parts, and paid out as follows:

- i. 50% will be offered and paid to the Whistler Community Services Society for its general community purposes, and
- ii. 50% will be placed in a fund created by our company to subsidize the housing costs of our employees amidst the current housing crisis within the RMOW.

For greater certainty, we will always be available and willing to formalize the commitments set forth within a more detailed contribution agreement negotiated with the Nations, Whistler Community Services Society, the RMOW, and any other appropriate stakeholders.

Whistler Community Services Society (WCSS)

Our office has communicated with Dave Clark, Director of Fundraising and Community Engagement with the WCSS, multiple times since May 2022. Most recently, Dave was able to introduce us to their team, providing a tour of their facility including the administration offices, the thrift store, and the food bank. It was impressive to see all the supportive programs that are offered to those in need in Whistler. The more conversations we have with other individuals and associations in Whistler, the more we hear of the great work being done at the WCSS and the impact it has. We were thrilled to be able to commit to becoming Blue Sponsors donating \$5,000 annually to the organization should we be successful in opening a store in the RMOW. We look forward to building this relationship and finding additional ways we can support WCSS in the future.

Should certain conditions be met, we will also distribute 1% of our top line revenues from our Whistler operation on an annual basis to WCSS which we predict based on our current operating locations to be approximately \$50,000 per year. Reference of this undertaking and these conditions can be found in Appendix A.

The Association of Whistler Area Residents for the Environment (AWARE)

We have been communicating with staff at AWARE and are thrilled to be able to offer \$1,000 annually to the organization. This is a very busy organization, and they are integral to the health and longevity of the resort through their programs, education, planning and consulting that they do year-round. We are happy to support the well

being of our community and environment in Whistler with this annual donation and look forward to finding other ways our store and operation can support their direction and initiatives in coordination with the *Zero Waste Action Plan* and *Whistler's Climate Action Big Moves Strategy*.

Whistler Offroad Cycling Association (WORCA)

Our office has had the pleasure of meeting with Trevor Ferrao, Executive Director of WORCA. The trails in Whistler are constantly enjoyed by ourselves, permanent residents, and visitors and we understand it is no easy undertaking keeping these trails maintained. We are happy to commit to becoming Silver level sponsors with WORCA donating \$1,000 annually to be used at their discretion where they need it most, and to provide boots on the ground volunteering throughout the year.

Whistler Housing Authority (WHA)

We have had the pleasure of speaking with Program Coordinators at the WHA to better understand the landscape and issues permanent resident workers have finding reasonably priced accommodation in the RMOW. Our company is committed to purchasing property in Whistler pending our approval and utilize this property to help house our staff. We will calculate the rates we charge our tenants in the same way the WHA does despite these properties not being part of their Employee Housing Ownership Program.

"WHA rental rates are based on 30% of the applicant's gross annual household income (with minimum and maximum rental rates for each property)."

We will also commit to installing an electric charger where possible through ChargePoint to incentivize and support our tenants to drive electric vehicles and reduce GHG emissions as part of *Whistler's Climate Action Big Moves Strategy*.

In addition to this, please reference Appendix A. This is a Letter of Undertaking that we have committed ourselves to with our lawyers which stipulates 1% of top line revenue annually that will be utilized to subsidize the housing expenses for our employees should certain conditions be met. This is expected to be approximately \$50,000 to be shared between our employees and will go a long way in securing an affordable living situation for them.

LEADERSHIP ON SUSTAINABILITY AND CLIMATE ACTION

Whistler thrives on mountain culture and the nature that surrounds it so it is imperative that the forests, lakes, rivers, and all that they sustain, are protected. As a business operating in this community, it is important that we do our part in protecting this environment.

Whistler's Climate Action Big Moves Strategy

As a retail business we will be able to execute on various mitigation efforts as set out in the Big Moves Strategy that was adopted by council on December 15, 2020.

Specifically, our company can help with moving beyond the car and closing the loop shifting toward lower carbon consumption.

"Personal vehicles are Whistler's largest source of GHG emissions, accounting for 54% of Whistler's total emissions in 2019"

As a company, we will incentivize and promote all our staff to move beyond car-based transport to active transport and increased transit use. Given our store is directly in Whistler Village, there is great access from bus routes from all around the greater Whistler area and we are within walking distance from most visitor lodging.

All deliveries made by our company in accordance with provincial laws will be completed with the use of an E-bike or by walking.

As previously mentioned, our company is also committing to purchase property in Whistler pending approval of our application and will commit to installing a ChargePoint home charger to support the use of EV vehicles by our staff when renting the property.

Zero Waste Action Plan

"The conservation of all resources by means of responsible production, consumption, reuse, and recovery of products, packaging, and materials without burning and with no discharges to land, water, or air that threaten the environment or human health"

Commercial and Strata made up 72.4% of landfill waste in 2020. We are happy to report that all of our locations have utilized a recycling program through EcoAction Recycling since 2021. They provide a recycling solution specific to the Cannabis Retail Industry. The solution provides retailers and customers with an easy way to recycle their cannabis packaging in-store and ensure all packaging rotates through a Circular Economy. It is a great way to show our customers we are helping protect the planet and by choosing us, they are too.

PRODUCT

Products Sold

Cannabis products sold in our stores include but are not limited to flower, pre-rolls, edibles, extracts and concentrates such as CBD oil and capsules, topicals and cartridges. All cannabis products must be purchased through the BC Liquor Distribution Branch (BCLDB; the provincial body that vets and purchases product from licensed producers across the country to ensure all products offered wholesale to cannabis retailers in BC are in

compliance with Health Canada). Accessories used for the consumption of our store can and will be purchased through wholesalers across Canada. We will also sell merchandise such as branded clothing and re-usable tote bags to cut down on single use products.

SECURITY REPORT AND CRIME PREVENTION THROUGH ENVIRONMENTAL DESIGN (CPTED)

We have conducted a Physical Security Assessment and Crime Through Environmental Design (CPTED) report in coordination with Paladin Risk Solutions Inc. Please refer to Appendix C. This report has highlighted measures specific to our location in Whistler Village to ensure we make the store a safe, secure place to conduct business for both customers, staff, and our neighbours.

SECURITY COMPLIANCE

We have worked closely with the province and Paladin Risk Solutions Inc. to ensure that our security systems in place far exceed what is required for licensed cannabis retail stores in BC. We do not take the safety of customers, employees, deliveries, and inventories lightly in an industry that is still relatively new. At a minimum, the province requires we have the following security measures:

1. An audible intruder alarm system monitored by a third party
2. An audible fire alarm system monitored by a third party
3. Locked retail display cases
4. Locked storage room
5. Secure perimeter door locks
6. Security cameras with full unobstructed view of the retail sales area, any product storage, and the interior and exterior of all entrances and exits
7. Frosted windows to negate visibility into the store from the exterior

In addition to this, we will also utilize the following safety measures specific to this location in Whistler Village:

1. A entrance into our store through a double wide door allows the delivery of a full pallet in just a couple minutes. This allows product to be brought from the delivery truck into our vault, immediately reducing the risk of theft or breakage.
2. Glass break sensors
3. Door contact sensors
4. 360-degree motion sensor cameras in our vault and public retail area
5. Steel bars on all windows
6. Panic buttons at each payment terminal, in our vault, and in the back staff area

7. Signage at entrances and exits indicating age restrictions and use of closed-circuit television (CCTV)

DESCRIPTION OF OPERATIONS

Staffing

Employees in our store must be at least 19 years of age and must produce ID for inspectors if asked at any time while working. They must also provide the province with their updated home address, telephone numbers, email or legal name change within ten days of a change.

All employees must get their Selling it Right updated every year (a process done through the province). This includes any adult performing work-related activities in the retail store on a full time or part time basis. This process is separate and distinct from the licensing process.

We will staff a minimum of 8 employees at this specific location.

Hours of Operation

This Is Cannabis proposes to be open seven days a week from 9am-11pm as is set out by the province.

Educational Initiatives

General Training

All employees go through our internal training programs to ensure each staff member is well versed in dealing with customers, non-medical cannabis and cannabis accessories, opening and closing procedures, and compliance. All employees must also complete the Selling it Right certification which outlines the responsible sale of cannabis and cannabis accessories. In addition, employees will be trained to handle intoxicated patrons, violent or disorderly conduct, and to take preventative measures to prevent disturbances. It is very important for This Is Cannabis that all employees can offer knowledgeable and trustworthy service to its customers and mitigate potential negative impacts on our neighbours and the community.

Product Training

We are happy to compensate any educational programs that our staff want to complete to increase their knowledge of cannabis and the education they can then pass on to our customers. Many of our staff complete the Interpening Course through the Trichome Institute – the leading cannabis sommelier course:

Understanding the complexity of cannabis effect types through their aroma spectrum is the unique *art and science* to becoming an Interpener.

Interpeners overcome the complexities of cannabis flower by evaluating the overall quality and predicting the effects based on aroma profiles and sensations.

As a sommelier tastes, smells and identifies wine varieties, an Interpener achieves the same with cannabis. Throughout the course, you will learn about the similarities between cannabis and wine and how the process of interpening cannabis quality, flavor, effects, and more was inspired by the culture of sommeliers.

An Interpening Certification will help you:

- Accurately determine flower quality without a lab test
- Pinpoint the psychoactive effects of flower within the sedative to stimulating spectrum
- Become proficient in cannabis terminology, anatomy, and speciation
- Navigate the many myths and challenges within the cannabis industry
- Guide customers, family, and friends how to select the best flower for their needs

Zero Waste Training

We will implement company wide education and training programs with all of our staff to be included with their typical operational training when they start employment with us. We have proactively met with the RMOW and will follow the same programs they have in place. We will also implement a "Waste Reduction Champion" in our store to increase awareness around waste, to make sure we present clear up to date and standard signage in our stores, and to ensure compliance with our strategic and operation goals to reduce our carbon footprint.

Corporate Structure

Ryan and Cody are owner operators of This Is Cannabis spending every Monday to Friday in their shops. They will be focused specifically on their Whistler location upon approval to ensure the store opens with the same high standards that they have for their other locations. The store in Whistler will have one Store Manager to oversee the whole operation, one Waste Reduction Champion to execute on our waste reduction plans, multiple Keyholders, and a few Sales Associates.

Customers and Target Market

We are restricted to selling non-medical cannabis, cannabis accessories, gift cards, and shopping bags to retail patrons that are 19 years of age or older.

If there is any doubt whether a patron is 19 or over, we must take reasonable steps to verify the age by requesting two pieces of ID, examine both pieces carefully, and act on the authenticity of the identification. If the patron cannot produce two pieces of acceptable ID, service must be refused. Primary ID must be issued by a government agency and must include the holder's name, date of birth, and picture (types of acceptable primary ID include province or states driver's license, passport, photo BC services card, citizenship card, certificate of Indian status, or federal firearms possession and acquisition license). A secondary ID used to verify the authenticity of the first piece must include the holder's name and must include either the holder's signature or picture

(types of acceptable secondary ID include BC services card, interim driver's license (issued by ICBC), BC transit ProPASS, university or college student card, credit card, Canadian blood services donor card, transport Canada's pleasure craft operator's card, many bank cards and rewards cards, and national defense ID).

Our target market encompasses a wide range of individuals including new and legacy users ranging in age from early twenties to seniors. We take pride in offering beautifully designed stores, welcoming and friendly customer service catered to each individual, and a wide array of quality products. The customers we aim to attract are those that respect and desire this elevated experience.

Sales Record Keeping

We must keep the following records for a period of at least six years from the date the records were created:

1. Non-medical cannabis sales records, including quantity of non-medical cannabis sold and prices charged
2. Non-medical cannabis disposal records
3. Sales records respecting cannabis accessories and prepaid purchase cards (gift cards) sold by us in the store.

Staff Record Keeping

We must keep a record of every worker's Selling it Right for inspection by inspectors. We must also keep a record of their names, addresses, salaries, qualification information, primary job responsibilities, shift schedules and dates of employment.

Return Policies

Non-medical cannabis products that show no signs of visible tampering may be returned with a receipt. Cannabis accessories may not be returned once opened except for recalled or defective product.

Compliance Procedures

As a licensee, we are required to:

1. Comply with the Cannabis Control and Licensing Act, its Regulations and the terms and conditions in the BC Cannabis Handbook
2. Always allow Liquor and Cannabis Regulation Branch inspectors and/or police officers to enter our establishment. We must never impede their entry in any way
3. Upon request, provide inspectors with any documents and/or records as outlined
4. Never draw attention to inspectors inside our establishment to not affect the inspector's safety

If an inspector observes a contravention to the Liquor Control and Licensing Act, Cannabis Control and Licensing Act, regulations or the terms and conditions of the licence, authorization or permit:

1. We will be issued a Contravention Notice

2. We may need to attend a compliance meeting, a meeting between management, our staff and the inspector to promote voluntary compliance
3. If the contravention is a recurring problem or a threat to public safety, the inspector may recommend enforcement action. If the branch proceeds, we will receive a Notice of Enforcement Action
4. We may be given a suspension, monetary penalty or licence cancellation. The branch can also recommend additional terms and conditions (such as shorter hours) or take back existing privileges. A permittee may be given either a monetary penalty or permit cancellation
5. We may be permitted to choose between a fine or licence suspension if:
 - it is the first contravention of a licence or authorization for the 24-month period preceding the contravention, and
 - the minimum of either penalty (monetary penalty or suspension) prescribed in the penalty schedule is suitable, and
 - we sign a waiver agreeing the contravention occurred
6. We can either sign a waiver accepting the penalty or request an adjudicated hearing
7. If a suspension is issued, it will begin on a business day of the same name as when the initial contravention occurred (for example, on a Friday). It will continue on successive business days until the period of the suspension is complete. Contraventions identified after midnight are considered to have occurred on the date the work shift began.
8. If we are dissatisfied with the outcome of the adjudicated hearing, we may apply to the branch for reconsideration within 30 days if:
 - there is new, substantial and material evidence that was not available at the time of the original hearing, or
 - there was an error of law on the face of the record, or
 - there was a breach in the common law rules of procedural fairness
9. If we are dissatisfied with the reconsideration order, we may apply to the B.C. Supreme Court for a judicial review of the decision within 30 days of receiving the order
10. If we do not qualify for reconsideration and are dissatisfied with the decision made at the adjudicated hearing, we may apply to the B.C. Supreme Court for a judicial review of the decision

INSURANCE COVERAGE INFORMATION

HUB Insurance is the insurance broker for This Is Cannabis and have been since June, 2019. A copy of the Certificate of Insurance evidencing liability insurance that has been extended to the location at 4293 Mountain Square, Whistler, BC can be found in Appendix B. If our application is approved, we will arrange to provide broad form



property coverage for the Tenant Improvements while under construction and then once the store is ready to be opened for business, we will provide broad form property insurance covering the Tenant's Improvements, furniture, fixtures, equipment, inventory and business interruption insurance. We will also amend the current Commercial General Liability insurance to recognize that the business is operational as a licensed Cannabis retail outlet. We have successfully executed this same model twice in our history without any issues.



APPENDIX A – LETTER OF UNDERTAKING



LETTER OF UNDERTAKING

TO: Resort Municipality of Whistler, 4325 Blackcomb Way, Whistler, B.C. V8E 0X5
FROM: 1211633 B.C. Ltd., c/o 201 – 45793 Luckakuck Way, Chilliwack, B.C. V2R 5S3
RE: Approval of RMOW Temporary Use Permit Application for Cannabis Retail (the "Proposal")

WHEREAS:

1211633 B.C. Ltd. (the "Applicant") has submitted the Proposal to the Resort Municipality of Whistler in support of its intention to open and operate a cannabis retail store at premises located at #201A & #201B 4293 Mountain Square, Whistler, BC V0N 1B4 (the "Location").

NOW THEREFORE in consideration of the approval by the Resort Municipality of Whistler (the "Municipality") of the subject Proposal, the Applicant hereby undertakes as follows:

1. Upon commencing operation of the cannabis retail business at the Location, the Applicant will:
 - a. create an annual \$50,000.00 scholarship fund for the benefit of Capilano University (the "Scholarship"); and
 - b. provide an annual distribution as of the anniversary date of the commencement of the Location's operation equal to 2% of the Location's top-line revenue (the "Annual Distribution"), with each such annual distribution projected to be approximately \$100,000.00.
2. For greater certainty, the Scholarship will be available solely to Indigenous persons, with preference given to the Skwxwú7mesh and Lílwat7úl peoples (together, the "Bands").
3. In respect of the Annual Distribution, the Applicant will approach each of the Bands, through their respective community economic development companies being the Skwxwú7mesh Nch'Kay Development Corporation and Lílwat7úl Economic Development Division, to offer each 50% of the Annual Distribution to be used for each band's community and economic development purposes, provided that:
 - a. if, within 60 days, only one Band accepts the offer of the Annual Distribution, then the entire Annual Distribution will be made available to the accepting Band; and
 - b. if, after 60 days, neither Band has accepted the offer of the Annual Distribution, or a portion thereof, the Annual Distribution will instead be divided into two parts, and paid out as follows:
 - i. 50% will be paid to the Whistler Community Services Society for its general community purposes, and
 - ii. 50% will be placed in a fund created by the Applicant to subsidize the housing costs of the Applicant's employees amidst the current housing crisis within the Municipality.

4. For greater certainty, the Applicant will at all times be available and willing to formalize the commitments set forth herein within a more detailed contribution agreement negotiated with the Bands, Whistler Community Services Society, the Municipality, and any other appropriate stakeholders.
5. This Undertaking is a fully binding and enforceable legal obligation of the Applicant, for the benefit of the Municipality.

The undersigned acknowledges that the Municipality is relying upon this Undertaking in approval the Proposal.

Dated as of March 10, 2023.

1211633 B.C. Ltd.

Per:



Cody Les, Director

APPENDIX B – INSURANCE COVERAGE





February 14, 2023

To Whom it May Concern:

We are the insurance broker for 1211633 BC Ltd and have been since their inception in June, 2019. Please find attached a current Certificate of Insurance evidencing liability insurance has been extended to the location at 4293 Mountain Square, Whistler, BC.

If the permit application is approved, we will arrange to provide broad form property coverage for the Tenant Improvements while under construction and then once the store is ready to be opened for business, we will provide broad form property insurance covering the Tenant's Improvements, furniture, fixtures, equipment, inventory and business interruption insurance. We will also amend the current Commercial General Liability insurance to recognize that the business is operational as a licensed Cannabis retail outlet. 1211633 BC Ltd has successfully executed this same model twice in their history without any issues.

Sincerely,

A handwritten signature in black ink, appearing to read 'Bryce Lewis', written over a circular stamp or mark.

Bryce Lewis
Commercial Account Executive
(604) 703-7070
Bryce.Lewis@hubinternational.com



Certificate of Liability Insurance

This certificate of Insurance neither affirmatively nor negatively amends, extends or alters the coverage afforded by the policies scheduled herein. It is furnished as a matter of information only, confers no rights upon the holder and is issued with the understanding that the rights and liabilities of the parties will be governed by the original policy or policies as they may be lawfully amended by endorsement.

| | |
|---|---|
| Certificate Holder Mountain Square Holdings Ltd. c/o Macdonlad Commercial Real Estate Services Ltd. 1827 West 5 th Avenue, Vancouver, BC V6J 1P5 | Name and address of Insured 1211633 BC Ltd. 106-7670 Vedder Road Chilliwack, BC V2R 4G9 |
|---|---|

| Type of Insurance | Insurer | Policy Number | Deductible | Limits of Liability |
|--|--|---------------|--|---|
| Commercial General Liability - Includes Cross Liability and Severability of Interests | Peace Hills General Insurance Company as Arranged by Cansure | CS582257 | \$2,500 Bodily Injury/Property Damage Deductible | \$5,000,000 Bodily Injury & Property Damage – Each Occurrence \$5,000,000 Products Completed Operations – Aggregate \$5,000,000 General Aggregate \$5,000,000 Non-Owned Automobile Liability \$1,250,000 Tenants Legal Liability – Any One Premises |

Effective Date: June 1, 2022 to Expiry Date: April 3, 2023

Operations Covered: Lease of unit #201 – 4293 Mountain Square, Whistler, BC

Additional Insured(s): Mountain Square Holdings Ltd. and Macdonlad Commercial Real Estate Services Ltd.

It is hereby understood and agreed that Mountain Square Holdings Ltd. are added as Additional Insureds to the above noted policy with respect to Commercial General Liability – but only with respect to the operations of the Named Insured. Policy limits are not increased by such addition. Includes Waiver of Subrogation in favor of Mountain Square Holdings Ltd.

CANCELLATION NOTICE:

Should the above described policy be cancelled before the expiration date thereof, the Insurer will provide 30 days written notice to the Certificate Holder.

Issued at: Chilliwack, BC

HUB International Insurance Brokers

Date: February 14, 2023

Authorized Representative

APPENDIX C – PHYSICAL SECURITY ASSESSMENT





**Paladin
Risk Solutions**

**PHYSICAL SECURITY
ASSESSMENT**

**For:
THIS IS CANNABIS**

**At:
4293 Mountain
Square Whistler, BC**

Table of Contents

- 1. INTRODUCTION & PROJECT METHODOLOGY.....3
- 2. ASSESSOR PROFILE3
- 3. IDENTIFIED VULNERABILITIES.....4
- 4. RISK ASSESSMENT PROCESS.....4
- 5. RISK MATRIX.....5
- 6. RECOMMENDATIONS5
- 7. CRIME PREVENTION THROUGH ENVIRONMENTAL DESIGN6
- 8. CPTED STRATEGIES7
- 9. THE FOUR PRINCIPLES OF CPTED.....7
- 10. CRIME ANALYSIS8
- 11. CAP INDEX REPORTING.....11
- 12. SITE OVERVIEW12
- 13. CANNABIS RETAIL STORE TERMS & CONDITIONS.....13
- 14. SECURITY LAYOUT14
- 13.1 SECURITY DEVICE LOCATION RECOMMENDATIONS14
- 15. SECURITY DEVICES.....15
- 16. POLICY & PROCEDURES21
- 17. SECURITY RESPONSE22
- 18. PROTECTING YOUTH - IMPACT ON SURROUNDING AREA23
- 19. LIGHTING24
- 20. EXECUTIVE SUMMARY.....27

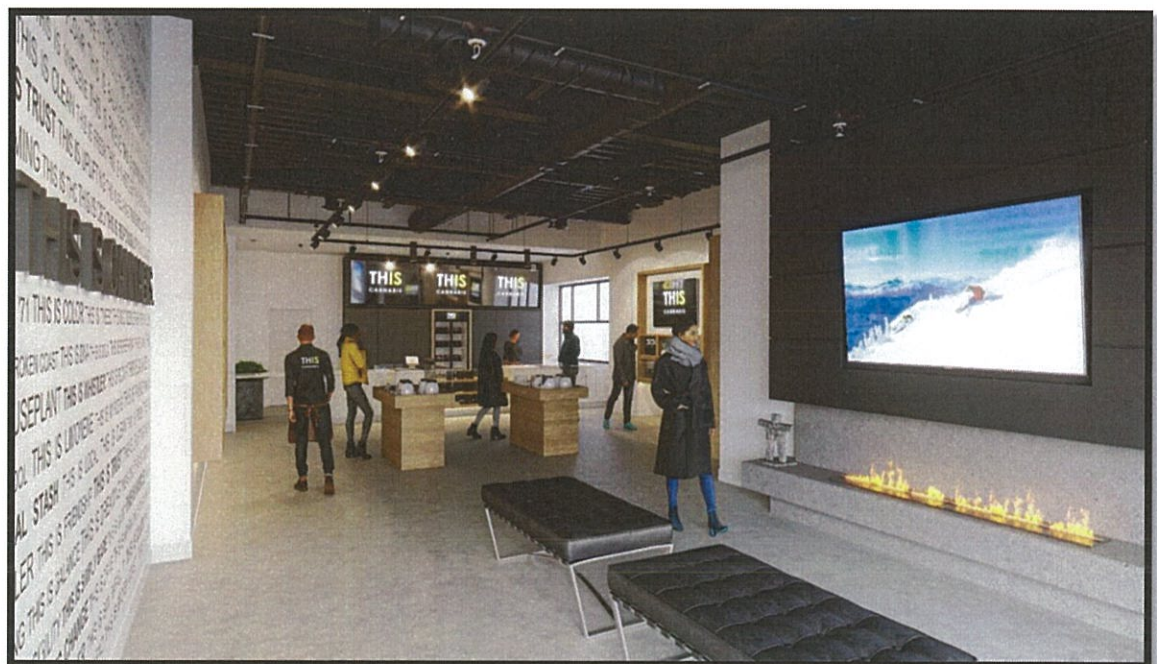

1. INTRODUCTION & PROJECT METHODOLOGY

Paladin Risk Solutions utilizes industry accepted best practices in Physical Security and Crime Prevention Through Environmental Design (CPTED). The primary focus of this report is on physical security and crime prevention through environmental design. Although this report references elements of building safety, compliance, and fire hazard prevention, these elements are largely beyond the scope of this report and should be addressed respectively.

The observations made by the assessor and presented in this report are based on industry standard references such as the ASIS General Security Risk Assessment (GSRA) Guideline, best practices, acquired knowledge, and the assessor's professional experience in efforts to tailor the suggested mitigation options to the physical and operational needs of the Property. Solutions for consideration listed within the report do not necessarily include every option available, but rather present some of the most common options employed within the security industry. For the purpose of this assessment, we are proposing a three-phased approach:

Phase I – Documentation Review

The goal of the document review is to understand the security profile of the environment in which the store is going to operate.

As part of the assessment, the following documentation will be reviewed:

- BC Cannabis Retail Store Terms and Conditions
- Security Plans
- Store Floor Plans
- Store Security Technology Plans
- Exterior Plan: including lighting and security technology
- Security Incident Reports (all locations)
- Security SOPs
- RMOW Official community Plan
- RMOW Council Policy G-27

During this phase of the project, we will also conduct a crime statistics review based on the publicly available police data to assist us with identifying threat profile for the property.

Phase II – On-site review

On-site review will be conducted to understand the security profile of the area during both day- and night-time (as per industry standards). Daytime audit provides an insight into how the area operates during business hours. During the night audit, lighting levels around the store are assessed. As this is a renovation to an existing retail space, risk levels will be determined using current hardware in place and than a reevaluated mitigated risk score assigned dependant on execution of recommendations.

Phase III – Report Generation

All the collected information will be assessed and presented in a comprehensive report outlining observations and recommendations relevant to CPTED guidelines and industry best practices. The final report will include legacy statistics from This Is Cannabis other store locations in Chilliwack and Abbotsford to establish best business practices and history of compliance through continuity among all their retail stores.

2. ASSESSOR PROFILE

Michael Langlois, CPP - Director of Risk

Michael is a highly accomplished Security Risk Management and Certified Protection Professional with over 15 years of experience designing and overseeing risk mitigation and security programs.

Michael has assisted corporate clients with risk strategies in the oil and gas, mining, critical infrastructure, cannabis, and transportation sectors and has provided operational management for the provincial and municipal government.

He has successfully developed and coordinated numerous security and safety policies and procedures and implemented multiple large project plans and deployments. His proven experience has impacted public safety and corporate security strategies, programs, and initiatives.

As a risk mitigation expert Michael has assisted corporate clients in strategic continuity and security planning including some of Canada's longest and most complex labour risk deployments for clients such as Ikea, Coca Cola, and Ontario corrections.

Previously, Michael served as the Head of Security for an international corporation, publicly traded on the TSX and NASDAQ exchanges in the cannabis sector. He aligned company goals, KPI, and program metrics for security priorities, employee safety, and business decision-making.

He was instrumental in establishing a gold standard program for security operations, compliance with Health Canada cannabis regulations, employee and public safety, technology-based controls, and creating emergency management response and recovery plans.

Michael is well-known for human safety and security compliance training, having designed, and delivered knowledge and competency-based training in highly regulated cannabis and aviation security industries. He is an innovative and strategic thinker applying his experience and energetic approach partnering with clients to understand their complex issues and provide solutions that will enable successful business continuity and risk mitigation strategies.

3. IDENTIFIED VULNERABILITIES

| VULNERABILITIES | CURRENT RISK LEVEL | MITIGATED RISK LEVEL |
|-----------------|--------------------|----------------------|
| ACCESS CONTROL | ELEVATED | LOW |
| MAIN ENTRY DOOR | ELEVATED | LOW |
| SECURITY LAYOUT | ELEVATED | LOW |
| VAULT AREA | MODERATE | LOW |

4. RISK ASSESSMENT PROCESS

The Threat Risk Assessment (TRA) is the industry's identified best practice to adopt for security, safety, and risk management. It identifies, quantifies, and qualifies the risks for dissemination to all departments, both internal and external, of an organization.

MITIGATION

Recommendations to improve the countermeasures associated with these vulnerabilities are discussed in Section 4 assisted with photographic documentation. The Risk Assessment Matrix is a descriptive tool to illustrate the level of threat based on the likelihood of the threat occurring, combined with the impact of the threat.

The resulting risk levels are:

Critical A security deficiency is identified with potential for material financial loss, serious injury, physical damage or adverse publicity and there is no current protocol in place to detect or mitigate the occurrence.

High The same as critical there is a security protocol in place; the protocol is assessed as insufficient to detect or mitigate the occurrence.

Elevated A security deficiency is identified with potential for financial loss, personal injury, damage, or adverse publicity. There is a security protocol in place, but it is assessed as insufficient relative to the risk level.

Moderate A security deficiency is identified with potential for a financial or safety risk. There is an effective security protocol in place to prevent such occurrences provided the protocol is adhered to.

Low A security deficiency is identified with potential for minor financial, safety, physical damage, or publicity. The security protocol in place will mitigate the impact, as long as it is adhered to.

5. RISK MATRIX

| | | | | | | |
|-------------|---------------------|----------|---------------|---------------|-----------|---------------|
| PROBABILITY | 5 ALMOST CERTAIN | | | | | CRITICAL |
| | 4 CONCEIVABLE | | | | HIGH | |
| | 3 MODERATE | | | ELEVATED | | |
| | 2 POSSIBLE | | MODERATE | | | |
| | 1 RARE | LOW | | | | |
| | | 1 LOW | 2 MODERATE | 3 ELEVATED | 4 HIGH | 5 CRITICAL |

SEVERITY

6. RECOMMENDATIONS

| CATEGORY | INDUSTRY BEST PRACTICE | INDUSTRY STANDARD | BELOW STANDARD | |
|------------------------------|------------------------|-------------------|----------------|---|
| ACCESS CONTROL (Glass break) | ✓ | | | Recommend glass break sensors on windowpane adjacent to main entrance door and expand steel window bars to cover adjacent hallway panels and top glass panels above the main door |
| MAIN ENTRY DOOR | ✓ | | | Recommend ANSI Grade 1 latch lock dead bolt, with commercial grade astragal and reinforced latch plate. Grade 1 doorknobs units need to withstand 800,000 cycles, 6 door strikes and a 360-pound weight test. Grade 1 deadbolts need to withstand 250,000 cycles and a 10-door-strike hammer test. |
| SECURITY LAYOUT | ✓ | | | Point of sales cameras need to be set back behind the cashier and turned to include front of customer and cash register in camera FOV. Additional 360 motion to cover blind spot in southwest corner of the vault. Installation of additional panic alarm located inside the vault for duress redundancy. Installation of additional panic button in the back-office staff area so that panic alarms do not have a single point of failure by only being in the retail sales area front of house. |

| | | | | |
|---------------------|---|--|--|---|
| VAULT AREA | ✓ | | | Recommend vault be constructed with reinforced walls with expanded metal mesh with a plywood and drywall overlay. The vault door should be fitted with a steel door and frame with an ANSI Grade 1 latch lock, deadbolt, astragal, and reinforced latch plate. |
| SECURITY RESPONSE | ✓ | | | Designated staff member to verify “in real time” all security alarms after hours remotely and initiate a police response if required. |
| POLICY & PROCEDURES | ✓ | | | Recommend a comprehensive training program to include: <ul style="list-style-type: none"> • Regular panic alarm system testing • Creation of a more effective incident report template for ease of tracking and risk planning strategies • Cash handling procedures • Theft/robbery/break and enter protocols • CCTV use and chain of custody procedures (police) • Conflict resolution / de-escalation techniques • Refusal of service and store ban procedures |

7. CRIME PREVENTION THROUGH ENVIRONMENTAL DESIGN

Crime Prevention Through Environmental Design (CPTED) is a multi-disciplinary approach of crime prevention that uses urban and architectural design and the management of built and natural environments. CPTED strategies aim to reduce victimization, deter offender decisions that precede criminal acts, and build a sense of community among inhabitants so they can gain territorial control of areas, reduce crime, and minimize fear of crime.

The Security Risk Assessment is the industry’s identified best practice to adopt regarding physical security, safety, and risk management. It identifies, quantifies, and qualifies the risks for the organization and to limit asset loss or damage and liability, both internal and external for an organization. Suggested mitigations for those identified risks are described for each section.

If the recommendations are fulfilled, the risk level is recalculated to the mitigated or residual risk level. This guide is used as an overview of current risks to 4293 Mountain Square Plaza and to aid decision making in mitigation methods. Using the Qualitative approach described in the ASIS International General Security Risk Assessment Guideline for threat risk assessment, security vulnerabilities are assessed by the effectiveness of current security systems compared to the risk level of future loss events, which is based on historical and current information and intelligence.

A Holistic risk management or integrated risk management approach was used based upon the discussions and the observations of the assessor. An examination of the organizational principles and practices defines the corporations wide risk management activities.

The core concept focuses on the avoidance of so called "risk silos", namely the presence of disconnected functions and processes whose scope is limited to some particular aspect of risk, segmented by business lines or other internal firm demarcations.

The holistic approach to risk management has been a corner stone of successful, integrated risk management for many years, identifying and providing solutions for weaknesses of silo-based risk management which tends to organize risk management activities around only the physical risk principles. Holistic risk management tends to remain an aspirational target for many corporations.

8. CPTED STRATEGIES

There are three control strategies that can be applied that will aid in providing a higher level of security for any given site. It should be noted that the CPTED strategies will augment the overall security plan but will not stand alone as a singular method of mitigating a criminal element.

Mechanical Measures

The use of hardware and technology systems such as locks, steel bars on windows, access control systems and video surveillance are examples of common mechanical measures. These Mechanical measures alone cannot be relied upon to create a secure environment, but rather be used in conjunction with operational procedures and design strategies. The use of mechanical measures will provide physical protection and discourage criminals from targeting areas where these measures are in place.

Organizational Measures

Focus on policies and activities that encourage observation, reporting and where appropriate intervention. This would include training for This is Cannabis staff on strategies they can take to protect themselves and the space they occupy. It would also encompass routine patrol and enforcement by uniform security, law enforcement, or others. Criminals will generally avoid targets or victims when the public, police, security, staff, or others are able to observe and react.

Natural or Architectural measures

The design of the store to ensure the overall environment works more effectively for the intended clients and staff, while at the same time deterring crime. A well planned and laid out store will naturally have less opportunity for criminal activity. A poor design reduces the ability of intended users to apply appropriate measures to reduce crime and leads to circumvention of mechanical measures.

9. THE FOUR PRINCIPLES OF CPTED

Natural Surveillance

Natural Surveillance principle is based on the premise that criminals do not like to be observed or recognized, so they will look for environments where they can go unnoticed or where they can hide and easily escape.

Some typical ways to incorporate natural surveillance include:

- Keep areas well-lit to provide greater visibility both inside and outside the store. Building entrances should always be well lit and provide a clear line of sight from both inside and outside.
- Eliminate hiding spots. Where possible remove anything that will create blind spots or hiding places.
- Use convex mirrors to provide sightlines around blind corners.

Natural Access Control

Criminals will target a location where they feel that they are in control. It is possible to deny this sense of control clearly defining the store property and directing customers into a defined area.

Territorial Reinforcement

This principle is used to create a clear distinction between public and private property (the store). This is important for two reasons: Staff will have a sense of ownership and will notice, and even challenge, people who don't belong; people with criminal intent have a harder time blending in.

Common ways to implement territorial reinforcement include:

- Make sure staff have clear sightlines to all entrances
- Staff must have the ability covertly call for help by activating a panic button that triggers a silent alarm to the alarm monitoring station.
- Post CCTV signage at the entrance and within the store stating that the premises are monitored by CCTV 24/7.

Maintenance

When the store and the immediate area are well-maintained it sends the message that people notice and care about what happens in the area. This, in turn, discourages vandalism and other crimes. Security professionals refer to this as the "Broken Windows Theory" - the idea that one broken window will attract vandals to break another. A vandalized or derelict looking area then becomes more inviting to higher levels of crime. The store and surrounding area should be well-maintained to deter crime and appeal to customers.

10. CRIME ANALYSIS

WHISTLER, BRITISH COLUMBIA

Total crime 25% higher than National Average
Violent crime 6% Lower than National Average
Property crime 36% higher than National Average
(Higher crime figures are largely due to mountain bike & ski/snowboard theft)

Date & Last Updated: This data reflects 2020 and was released from [Statistics Canada](#).

Total crime includes all violent and property crime. Violent crimes include homicide, murder, assault, robbery, kidnapping, extortion, harassment, threats, and all other violent violations. Property crimes include breaking and entering, theft, motor vehicle theft, fraud, mischief, and all other property crime violations. Crimes not reflected in this table include criminal code violations, traffic violations, federal statute violations and drug violations. This crime data is estimated based on Statistics Canada data.

| Index | Whistler/100k people | British Columbia/100k people | National/100k people |
|----------------|----------------------|------------------------------|----------------------|
| Total crime | 5,293 | 6,040 | 4,223 |
| Violent crime | 982 | 1,120 | 1,042 |
| Property crime | 4,312 | 4,920 | 3,181 |

All Crime Incidents

All crime incidents include all violent and property crime as well as criminal code violations (child pornography, disturbing the peace, justice violations), traffic violations (impaired driving), federal statute violations and drug violations.

| Statistic | Whistler | British Columbia | National |
|---------------------|----------|------------------|-----------|
| Total incidents | 1,043 | 439,205 | 2,225,600 |
| Incidents per 100k | 7,478 | 8,532 | 5,856 |
| Change in 100k rate | -29.3% | -10.9% | -9.8% |

Persons Charged By Age Group (Per 100k)

| Statistic | Whistler | British Columbia | National |
|-----------------|----------|------------------|----------|
| All (12+ years) | 1,592 | 1,279 | 1,709 |
| Youths (12-17) | 423 | 672 | 1,108 |
| Adults (18+) | 1,662 | 1,322 | 1,757 |

Weighted Clearance Rates

More severe crimes such as robberies, assault and homicides are given more weight to the overall clearance rates. Less severe crimes such as vehicle theft, fraud and mischief are given less weight to the overall clearance rates.

| Statistic | Whistler | British Columbia | National |
|-------------------------|----------|------------------|----------|
| Clearance rate | 27 | 25 | 37 |
| Clearance rate change | -7.2% | -2.2% | 0.2% |
| Clearance rate violent | 49 | 44 | 58 |
| Clearance rate property | 20 | 19 | 27 |

Key Findings

Whistler crime rates are 25% higher than the national average
Violent crimes in Whistler are 6% lower than the national average
In Whistler you have a 1 in 19 chance of becoming a victim of crime
Whistler is safer than 51% of the cities in Canada
Year over year crime in Whistler has decreased by 31%

Chance Of Being A Victim Of Crime In Whistler

The chance of being a victim of violent crime in Whistler is 1 in 102
The chance of being a victim of property crime in Whistler is 1 in 24
The chance of being a victim of crime in Whistler is 1 in 19

Year Over Year Crime In Whistler

| Statistic | Whistler | British Columbia | National |
|-----------|----------|------------------|----------|
| Total | -30.8% | -8.3% | -7.9% |
| Violent | -33.0% | -2.6% | -3.6% |
| Property | -30.1% | -10.0% | -9.8% |

Nearby Cities With Low Crime Rates

| City | Population | Violent crime /100k people | Property crime /100k people | Total crime /100k people |
|--------------------------------------|------------|----------------------------|-----------------------------|--------------------------|
| Squamish-Lillooet BC | 1,153 | 388 | 1,704 | 2,092 |
| Whistler, BC | 14,292 | 982 | 4,312 | 5,293 |

Cities With Similar Population

| City | Population | Violent crime /100k people | Property crime /100k people | Total crime /100k people |
|-----------------------------------|------------|----------------------------|-----------------------------|--------------------------|
| Thames Centre, ON | 14,265 | 601 | 1,740 | 2,341 |
| Ingersoll, ON | 14,325 | 865 | 2,504 | 3,369 |
| Lavaltrie, QC | 14,339 | 668 | 1,303 | 1,971 |
| Warman, SK | 14,245 | 397 | 1,284 | 1,681 |
| Sainte-Adèle, QC | 14,237 | 703 | 1,371 | 2,074 |
| Whistler, BC | 14,292 | 982 | 4,312 | 5,293 |

Safety in Whistler, Canada

Whistler RCMP presents 2019 crime stats

Violent crime down; property crime, impaired driving up

WHISTLER RCMP unveiled its 2019 crime stats this week, which showed that violent crime was on the downturn last year, while property and impaired driving moved in the opposite direction. Presented to mayor and council at a Committee of the Whole meeting on Tuesday, Jan. 7, overall, the figures showed some promising trends. Violent crime, for instance, was down seven per cent, with 190 incidents in 2019 compared to 204 the year before. Assault, which, at 108, made up more half of the instances of violent crime, was down 20 per cent, from 134 incidents in 2018. Domestic violence went down 28 per cent, from 46 to 33 incidents, while weapons offences also dropped, from 12 to eight incidents.

The violent offence that went against this trend was sexual assault, which rose from 18 to 39 incidents, but this is partially linked to a shift in how the RCMP categorizes sexual assault. In January 2019, Stats Canada changed the definition of a "founded offence" to include reported incidents that are known to have occurred, were attempted or instances where there was no credible evidence to confirm it did not take place. Prior to that, only offences that were proven to have occurred were tallied.

The change comes after a comprehensive Globe and Mail investigation published in 2017 that analyzed how police forces across Canada handled allegations of sexual violence. At the time, it found that roughly a quarter of sexual assaults reported in Whistler were dismissed as unfounded.

Property crime, which has long been an issue for Whistler police, saw a slight jump of five per cent in 2019, from 576 reported incidents to 603. That included increases in auto theft (three to seven incidents); theft from vehicle (63 to 70); mischief to property under \$5,000 (120 to 144); and bicycle theft (31 to 48).

"I'm not entirely surprised by this," Triance said of the hike in property crime, adding that a handful of major investigations, including a sexual assault and a child abuse file, diverted detachment resources. "These larger files ... are going to take away from the time they have to focus on thefts and break-and-enters." The total value of bikes stolen in 2018 was \$85,000, which included the theft of a pricy mountain bike valued in excess of \$32,000 and is well down from the recent high of roughly \$300,000 in 2016.

"Although the number of thefts is up, the value is substantially down," noted Staff Sgt. Paul Hayes. "What that's telling us is that we seemed to have curbed the 'shopping criminals' that are coming up and looking for the high-end bikes." In other property crime, last year saw drops in both business (12 to 10 incidents) and residential break-and-enters (16 to 10), and theft under (160 to 146) and over \$5,000 (12 to three).

In drug crime, cocaine possession dropped by nine per cent last year, while "fentanyl-related offences" stayed identical to 2018, at three. In other notable crime trends, public intoxication fell 31 per cent, fraud dropped by 12 per cent, and mental health-related calls rose by 42 per cent, from 26 to 37. Triance said mental health, and connecting those in need to social services, is a top priority for RCMP in 2020. "We've been impacted this year by some serious incidents that we don't report on with media, but have impacted our community, so, anecdotally, just really know that that is an important part of our policing," she said.

Crime in Whistler was on a downward swing in 2020

Brandon Barrett Apr 23, 2021

Notable exceptions include domestic violence, harassment, and serious collisions. Bike theft in Whistler was one of several criminal categories that was down in 2020, another sign of the pandemic's effect on local crime.

In a year when the COVID-19 pandemic has changed so many elements of life, crime was no exception. Presenting at the Tuesday, April 20 Committee of the Whole meeting, Whistler RCMP gave elected officials a glimpse into the numerous ways the pandemic has shifted criminal patterns in the resort. Unsurprisingly, with tourism slowed to a trickle for much of the year, Whistler's criminal statistics were down across the board—with some notable exceptions.

Overall, violent crime dropped seven per cent, from 190 to 177 incidents. Assaults were also down, by nine per cent, from 107 to 97 reports, although within that category, assaults with a weapon or assaults causing bodily harm rose from nine incidents in 2019 to 12 last year. Sex offences overall were down 38 per cent, including sexual assault, which decreased from 29 incidents in 2019 to 17. Domestic violence, however, bucked that trend, increasing by 31 per cent, from 32 incidents in 2019 to 42 last year. This reflects a wider national and international trend during the pandemic, as the stress of lockdown has put victims at greater risk of intimate partner violence. "Some of this can be related to COVID. There has been an increase in some domestic situations where people are housed in the same houses," said Staff Sgt. Sascha Banks during the presentation.

Last year, the Sea to Sky RCMP created a specialized position to address domestic and sexual violence, launched with support from several local social-service organizations, which could have also contributed to the increase. "When we actually brought the domestic violence, sexual assault position into Squamish, we saw an increase in sexual assaults. And part of that would be because we have the tools and the relationships built with places like the Howe Sound Women's Centre, and we're able to do a bit more of the victim contact and make it a more positive environment because there's a lot of underreporting in those types of categories," Banks noted.

Harassment (23 per cent) and uttering threats (32 per cent) were also up, another possible effect of the pandemic, explained Banks. "Some of these can be related to some of that COVID-type behaviour that we're seeing where people are just getting upset and frustrated," she said. In a similar vein, mental health-related calls were unsurprisingly also up, rising five per cent from 2019, a trend that has continued in the early months of 2021, Banks said. "It's not rocket science that a lot of this has to do with COVID and what that's doing to people with the loss of jobs, finances, and the overall isolation that certain people are feeling," she added.

Property crime, meanwhile, saw a major decrease of 29 per cent, from 656 incidents in 2019 to 467, and was down in every related category save one: theft over \$5,000, which increased from four to five incidents. That includes bike theft, an issue that has stuck in the craw of local police for years, which dropped 27 per cent, from 51 to 37 incidents. Drug offences contributed to the overall downward slide, with possession charges declining a whopping 67 per cent, from 76 to 25 incidents, and well below the recent high of 2016, which saw 251 incidents. Trafficking charges were also down, falling from 23 to 12 incidents.

In terms of traffic safety, another major enforcement priority for local Mounties, the pandemic likely contributed to a 23-per-cent drop in overall motor vehicle incidents, while the severity of the accidents that did occur signalled a less promising trend. Collisions causing less than \$10,000 in damage rose from 75 to 95 incidents, while collisions resulting in more than \$10,000 in damage jumped 64 per cent, from 22 to 36 incidents. "You had some quite serious collisions within our area and to the north of us," Banks said, adding that police noted an increase in motorcycles in the area last summer, which likely contributed to the rise. "You have fewer people coming up here, but you have more serious collisions." Without its regular influx of revellers, Whistler also saw a 39-per-cent decrease in impaired driving, down from 544 incidents in 2019 to 330 last year.

In total, Whistler RCMP received 4,314 calls for service last year, a 15-per-cent drop from 2019. Local officers, who were vaccinated earlier this month, also issued \$69,940 in COVID-related fines between October 2020 and March 2021. "Our guys know how to do these tickets and they have a zero-tolerance policy," Banks said.

11. CAP INDEX REPORTING

A crucial factor in determining security requirements at any facility is the nature and extent of crime risk in the immediate and surrounding area. This section of the report will introduce and discuss the area crime risk in the context of the Property. The CAP ("Crimes against Persons/Property") Index methodology was utilized as it is the single most accurate predictor of risk and crime vulnerability available in Canada.

CAP Index data are derived from an advanced evaluation system designed to accurately identify the risk of personal and property crimes at any location in Canada. The CAP Index model is based upon the strong relationship that exists between a neighborhood's "social disorganization" and the amount of crime that is perpetrated there. The CAP Index model was developed by correlating a broad range of demographic variables with police crime statistics, survey information and other databases, with known indicators of crime.

The CAP Index model produces data-driven probability measures that place any location in context with the Canadian, Provincial and Local levels of crime risk. These probability measures are referred to as CRIMECAST scores. The types of crime risk identified via CRIMECAST data include homicide, sexual assault, robbery, assault, breaking and entering, property theft and vehicle theft.

The CRIMECAST score is the overall predictor of crime. It is a weighted average of the risk of sexual assault, robbery, and murder. CRIMECAST scores indicate a site's risk of crime. The scores are scaled so that a value of 100 is equal to the Canadian, Provincial or Local average. Scores over 100 represent above-average predicted crime risks; scores under 100 indicate below-average risks. CRIMECAST values range from 0 to 2000. The table below shows how to interpret the scores.

CRIMECAST® Model



A full *CAPIndex CrimeCast* report is attached. As *APPENDIX A*

12. SITE OVERVIEW

Paladin Risk Solutions completed a physical security review for the proprietors of This is Cannabis, at their proposed location, Unit 201 4293 Mountain Square Plaza Whistler, BC on Monday May 9. Located close to the center of the whistler mountain plaza this location also features many retail shops, restaurants, and hotels. The area during the day is frequented by many pedestrians, guests, and visitors.

This is cannabis is committed to meeting and exceeding the RMOW council policy G-27 by selecting a location and design to adhere to the below noted guidelines regarding village stroll frontage.

5.1 Location Guidelines

A cannabis retail store may be in a commercial unit that: **Cannabis Retail Policy Page 3**

- Is within an area described as a Temporary Use Permit area shown in Schedule 1.
- Is at least 300 m from the property line of any parcel containing an elementary or high school or Meadow Park Recreation Centre; and
- Does not have frontage on the Village Stroll as shown in Schedule 1

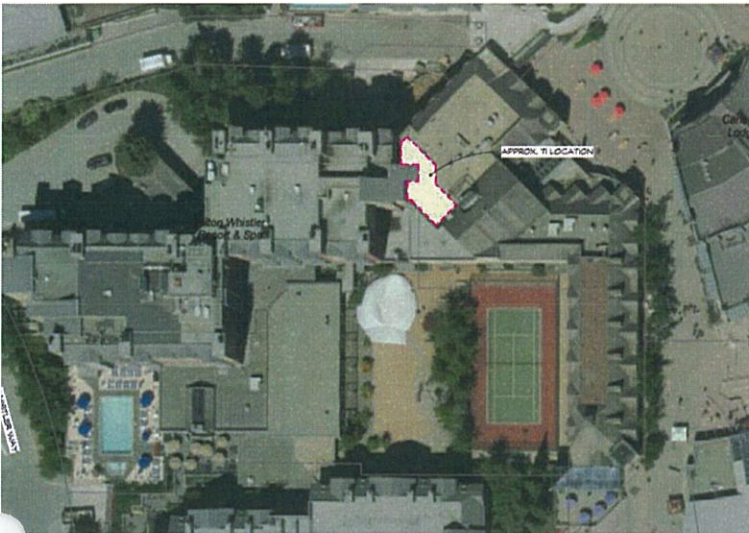



**Main store entrance with rendered visual design concept*

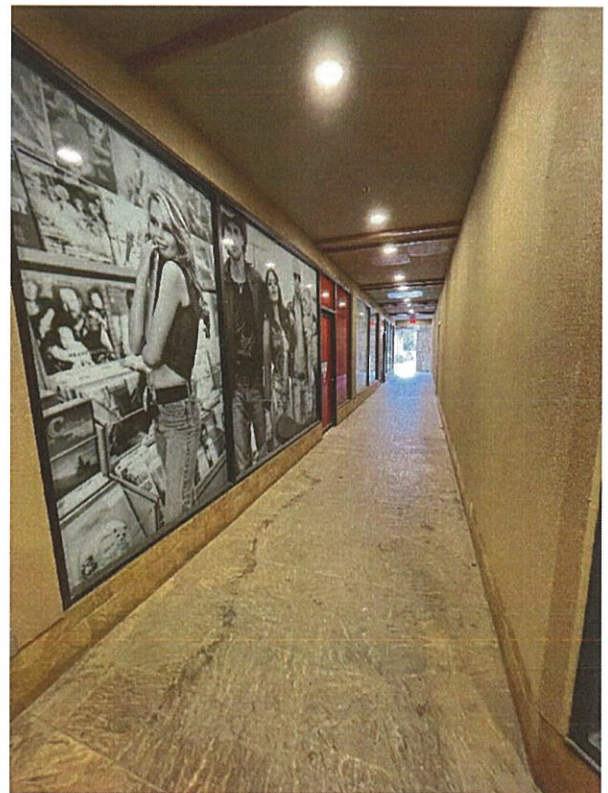

**Side hallway parallel to store*

13. CANNABIS RETAIL STORE TERMS & CONDITIONS

Store Security Requirements:

A cannabis retail store must be in a permanent building or structure and must, at a minimum, have the following security requirements:

1. An audible intruder alarm system monitored by a third-party
2. An audible fire alarm system monitored by a third-party
3. Lockable retail display cases
4. Locked storage area
5. Secure perimeter door locks
6. Security cameras with full unobstructed view of:
 - a) the retail sales area
 - b) any product storage area
 - c) both the interior and exterior of all store entrances/exits.

Licensees must post a written notice in the retail sales area informing their patrons that video surveillance is being used on the premises. This notice must be visible at all times.

The video surveillance camera(s) must be active and always recording, including when your store is not open for business. Licensees must store security camera footage for at least 30 days after recording.

Licensees must provide a copy of security camera footage to LCRB at any time for use in investigating possible contraventions of the Cannabis Control and Licensing Act, its regulations, and/or these terms and conditions. Security

camera footage may also be used by LCRB at enforcement hearings held under the CCLA.

14. SECURITY LAYOUT

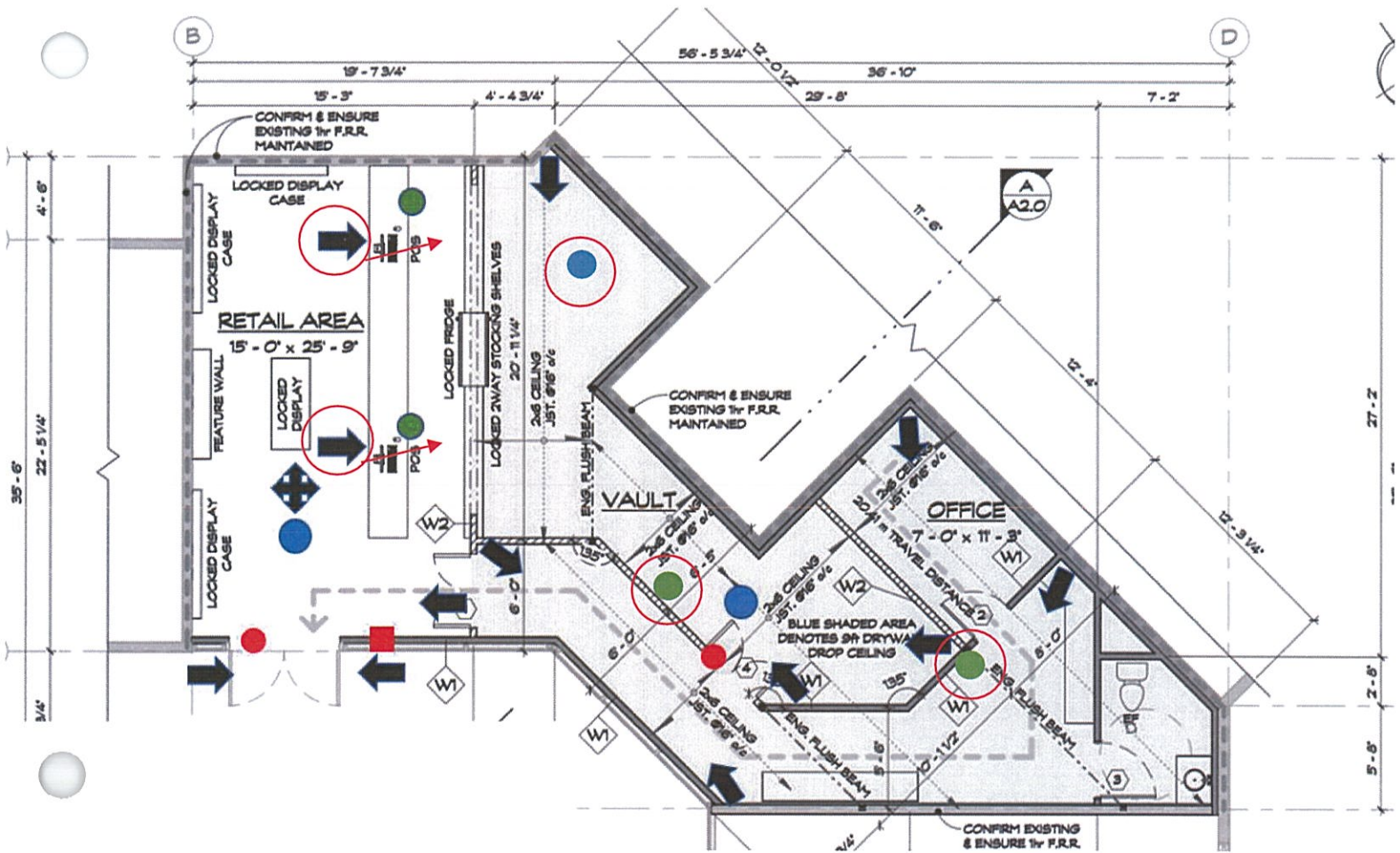

| SECURITY PLAN - LEGEND | | | | | |
|------------------------|--|-------------------|--|--------------|--|
| STATIONARY CAMERA | | 360 DEGREE CAMERA | | GLASS BREAK | |
| 360 DEGREE MOTION | | DOOR CONTACTS | | PANIC BUTTON | |

14.1 SECURITY DEVICE LOCATION RECOMMENDATIONS

1. Point of sales cameras need to be set back behind the cashier and turned to include front of customer and cash register in camera FOV.
2. Point of sales cameras need to be set back behind the cashier and turned to include front of customer and cash register in camera FOV.
3. Additional 360 motion to cover blind spot in southwest corner of the vault
4. Installation of additional panic alarm located inside the vault for duress redundancy
5. Installation of additional panic button in the back-office staff area so that panic alarms do not have a single point of failure by only being in the retail sales area front of house

15. SECURITY DEVICES

CCTV

The store will make extensive use of CCTV – both inside and outside the store. All cameras will be hi-resolution colour and set to record continuously. Security camera footage will be retained for at least 30 days after recording.

There will be a total of 12 cameras:

- One exterior camera left side of the entrance. This camera will capture images of people entering the store
- One exterior camera right side of the entrance. This camera will capture images of people entering the store.
- One interior camera just inside the front door covering entrance to restricted staff area
- Two (2) interior cameras directly above the point-of-sale areas
- One interior 360 camera to capture the entire sales area
- Three (3) interior cameras covering the entrance and coverage area in the vault
- Two (2) interior cameras in the staff area hallways
- One interior camera in the staff office

INTRUSION

The store will be protected throughout by a monitored intrusion alarm system. The system will use a network connection as well as a GSM (cellular) communicator as a backup communication path for the intrusion alarm system. The GSM will be used if the data connection is lost.

360-degree motion detectors will be installed in two main areas of the store:

- Front of house retail area.
- Inside the storage vault. (full coverage)

This will ensure that any attempt to breach the store outside of business hours will generate an alarm. Staff will have access to a total of Four (4) panic buttons that generate a silent alarm. They will be located at the point of sales area, inside vault, back-office staff area. Panic alarms automatically generate an emergency response by police that the store is under active threat.

PERIMETER

Door contacts that generate an intrusion alarm after hours will be installed on:

- Storage vault
- Main Entrance Door

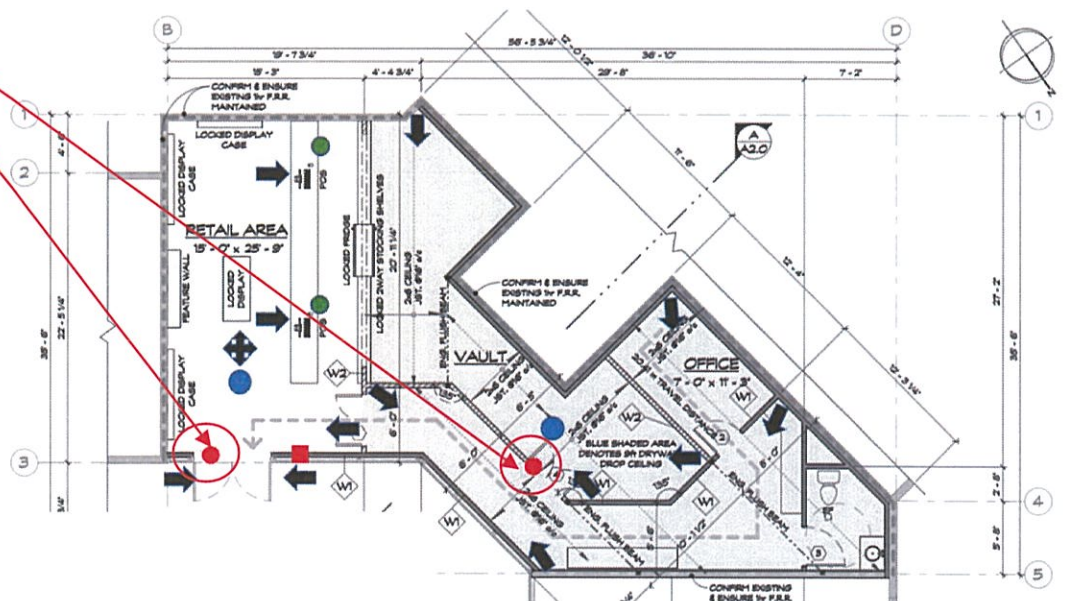

FIRE

The store is outfitted with a sprinklered suppression and is part of the retail center mountain square holdings fire alarm system.



ACCESS CONTROL

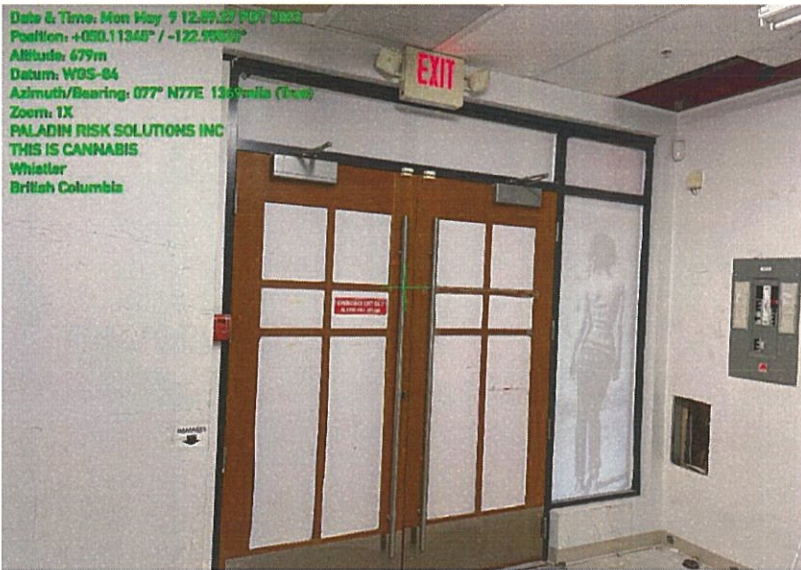

*Interior main entrance

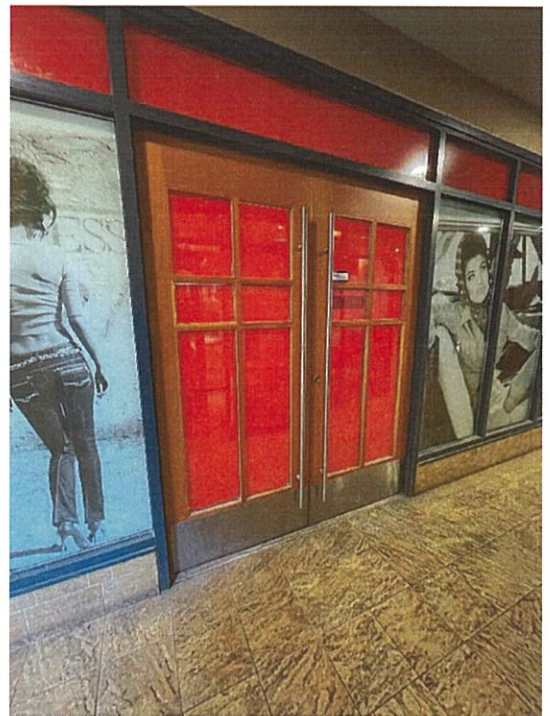

*Exterior main entrance

Main Entry Door

The main entry doors are currently secured with a mid grade Assa Abloy commercial latch lock

**Recommend all doors will be fitted with ANSI Grade 1 latch lock dead bolt, with commercial grade astragal and reinforced latch plate. Grade 1 doorknob units need to withstand 800,000 cycles, 6 door strikes and a 360-pound weight test. Grade 1 deadbolts need to withstand 250,000 cycles and a 10-door-strike hammer test.*



VAULT AREA

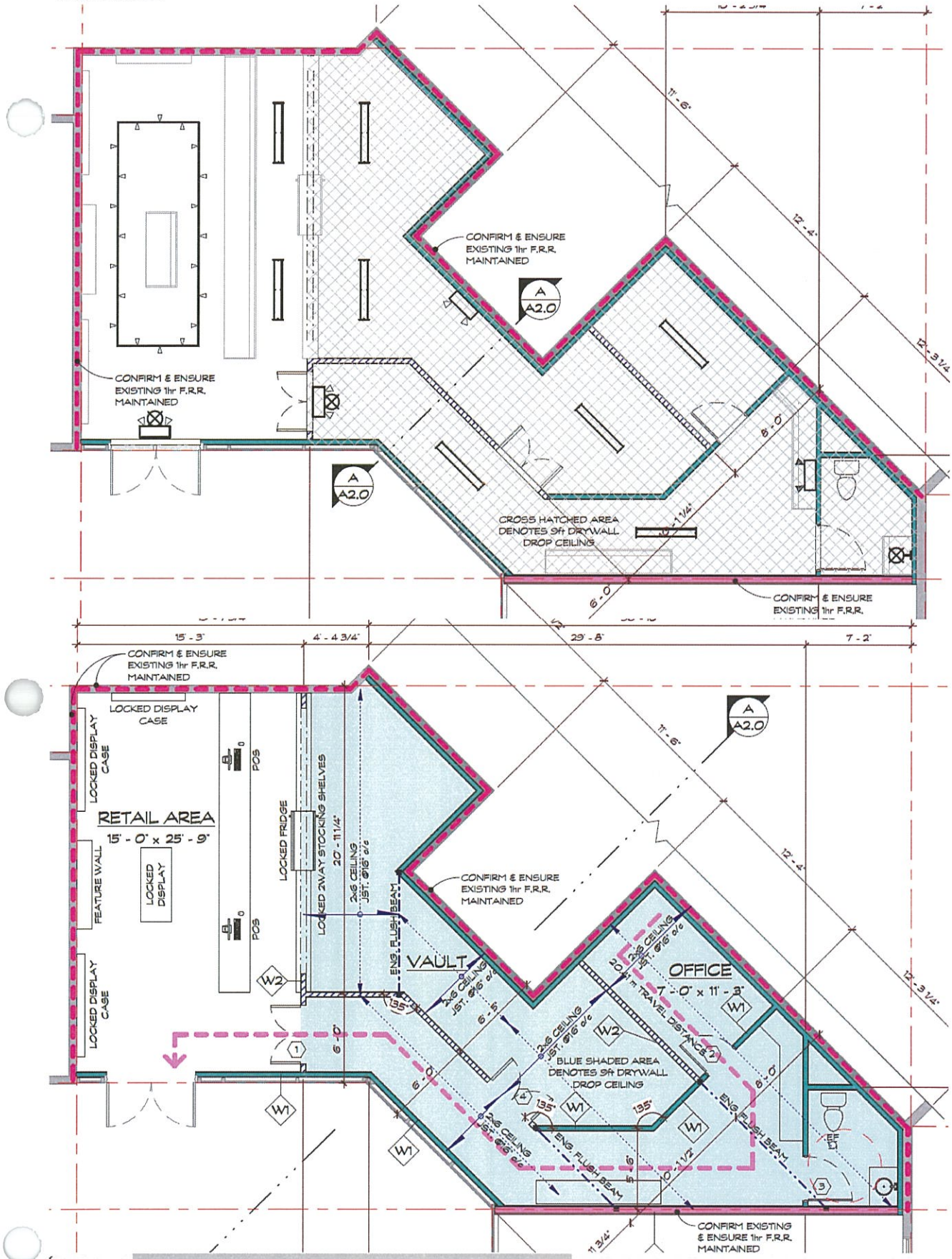

| DOOR SCHEDULE | | | | | | | |
|---------------|----------|--------|--------|-------|----------|--------------|-------------------------------------|
| SYMBOL | LOCATION | WIDTH | HEIGHT | TOTAL | MATERIAL | FIRE RATINGS | NOTES |
| 1 | INTERIOR | 4'-0" | 6'-8" | 1 | STEEL | N/A | DOUBLE DOOR, HANDLE, LOCKABLE |
| 2 | INTERIOR | 2'-6" | 6'-8" | 1 | WOOD | N/A | HANDLE, DOOR CLOSURE, LOCKABLE |
| 3 | INTERIOR | 3'-0" | 6'-8" | 1 | WOOD | N/A | PRIVACY SET ON BATHROOMS |
| 4 | INTERIOR | 4'-0" | 6'-8" | 1 | STEEL | N/A | VAULT DOUBLE DOOR, HANDLE, LOCKABLE |
| 7 | | 15'-0" | 7'-0" | 1 | | | OPENING |

| LEGEND | |
|--------|------------------------------|
| | CONCRETE WALLS |
| | 2x4/2x6 WOOD WALLS |
| | 2x4/2x6 BEARING WALLS |
| | EXISTING WALLS TO REMAIN |
| | EXISTING WALLS TO BE REMOVED |
| | EXISTING 1 hr F.R.R. |
| | 9# DRYWALL CEILING |

ALL EXISTING STRUCTURE, DIMENSIONS, MATERIALS, FINISHES, ROOF PITCH, OVERHANGS, HELL HEIGHTS TO BE CONFIRMED ON-SITE PRIOR TO ORDERING MATERIALS, OR COMMENCING DEMOLITION AND CONSTRUCTION

- ALL HEADERS IN EXTERIOR/INTERIOR BEARING WALLS TO BE 2/2x10, 3/2x10 OVER OPENINGS GREATER THAN 5'-0" WIDE UNLESS NOTED OTHERWISE
- DIMENSIONS ARE TAKEN FROM OUTER FACE OF PLYWOOD SHEATHING OR CONCRETE FOUNDATION TO CENTERLINE OF INTERIOR PARTITIONS OR EDGE OF FLOOR BELOW AND/OR ABOVE
- ALL DOORS LOCATED AT CENTER OF WALL OR WITH 4" FRAMED JAMB UNLESS NOTED OTHERWISE
- ALL F.R.R. FRAMING TO BE SUPPORTED BY ≥ F.R.R. STRUCTURE

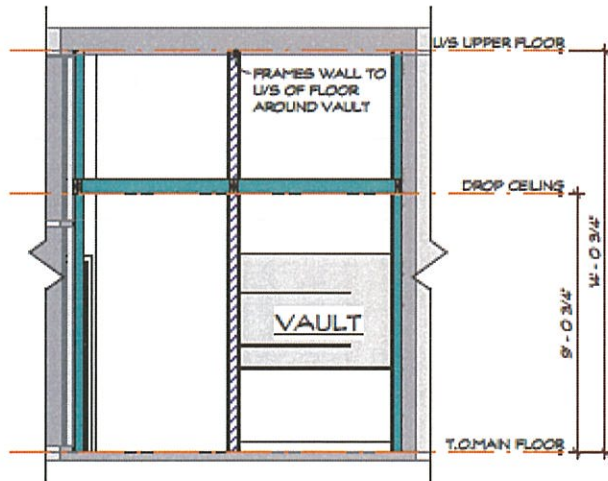

| ELEC. LEGEND | |
|--------------|--------------------------------|
| | EMERGENCY LIGHTING w/EXIT SIGN |
| | 4x8 STRIP (SURFACE/SUSPENDED) |
| | TRACK LIGHTING |

CROSS SECTION A
1/4" = 1'-0"

| ASSEMBLIES | |
|------------|---|
| W1 | INTERIOR WALLS 2x4 (OR 2x6) STUDS @ 16" o/c WITH DBL TOP AND SINGLE BOTTOM PLATES 1/2" GWS FINISHED |
| W2 | INTERIOR BEARING WALLS (HATCHED) 2x4 (OR 2x6) STUDS @ 16" o/c DBL TOP AND SINGLE BOTTOM PLATES 1/2" GWS FINISHED |
| W3 | INTERIOR WALLS (HR F.R.R.) AS STCS PER CBC 2018: TABLE A-9.10.3.1.1, ASSEMBLY W3a) 2x4 (OR 2x6) STUDS @ 16" o/c WITH DBL TOP AND SINGLE BOTTOM PLATES R-12 BATT INSULATION RESILIENT METAL CHANNELS @ 16" o/c (ONE SIDE) 5/8" TYPE X GWS FINISHED EACH SIDE |

*Interior vault area and door specifications meet industry standard specifications

GLASS BREAKS

The front facing windows at ground level will also be fitted with glass break sensors that detect high frequency vibration and forced intrusion (break) and will generate an alarm to the monitoring station for response.

**Front and side windows referenced below are also being fitted with security window bars, ½ inch square solid steel on 8"X 8" square pattern fabricated by S.T.I Steeltec Industries Ltd.*

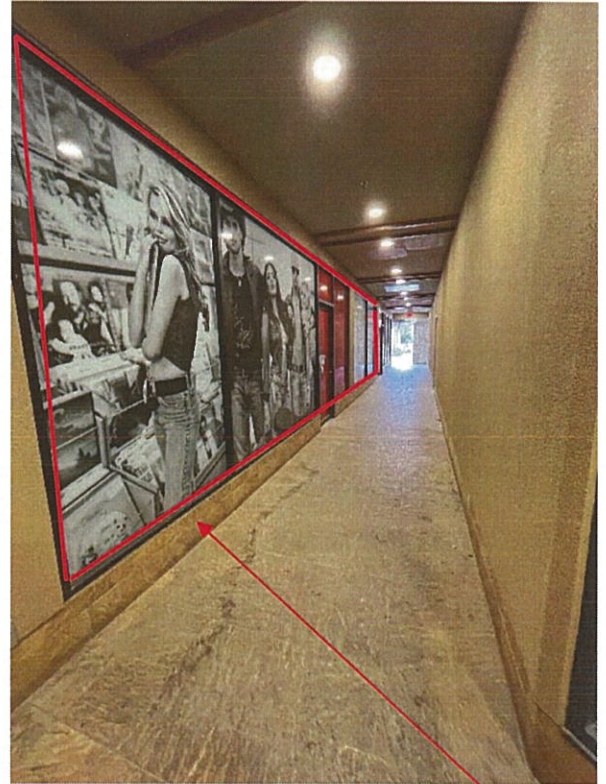

**Recommend application of fitted security bars and glass breaks along exterior corridor hallway glass running parallel to the front entrance.*

SIGNAGE

- There will also be signage posted outside at the front and rear of the store (and inside), advising that these premises are protected by an alarm system.
- There will be CCTV security signage at the front door and within the store warning that the area is under CCTV surveillance.
- There will be signage posted at the entrance that will warn that minors (under 19) are not allowed in the store.

16. POLICY & PROCEDURES

A detailed review of This Is Cannabis incident reporting was initiated for their two operating stores located in Chilliwack and Abbotsford BC, to determine risk profile of the areas, compliance to Cannabis regulations and to determine any adverse effects on surrounding stores and businesses for the past 1-2 years (since opening)

As outlined below it is clear that This is Cannabis is committed to protecting youth by actively confirming identification of all customers and refusing service when minors are brought into their stores. The incident reports also confirm that introduction of a cannabis retail store does not have adverse effects on surrounding areas indicated by no panic alarms triggered in Chilliwack or Abbotsford (2 were accidental depress) there were no reported break in attempts or robbery in either store. There were 1% non-emergency calls placed to police in Abbotsford and 4% in Chilliwack (half of the calls to police in Chilliwack involved alcohol related intoxication). All this information further evidence of no negative impact to surrounding stores and environment.

| CHILLIWACK | | | | | | |
|---------------|-------------------------|---------------|----------|-------|---------------------|---------------------------|
| REFUSED NO ID | REFUSED SERVICE w/Minor | REFUSED OTHER | PERM BAN | PANIC | REFUSED INTOXICATED | POLICE CALL NON-EMERGENCY |
| 105 | 18 | 5 | 0 | 0 | 6 | 6 |
| ABBOTSFORD | | | | | | |
| REFUSED NO ID | REFUSED SERVICE w/Minor | REFUSED OTHER | PERM BAN | PANIC | REFUSED INTOXICATED | POLICE CALL NON-EMERGENCY |
| 156 | 18 | 12 | 4 | 2 | 8 | 1 |

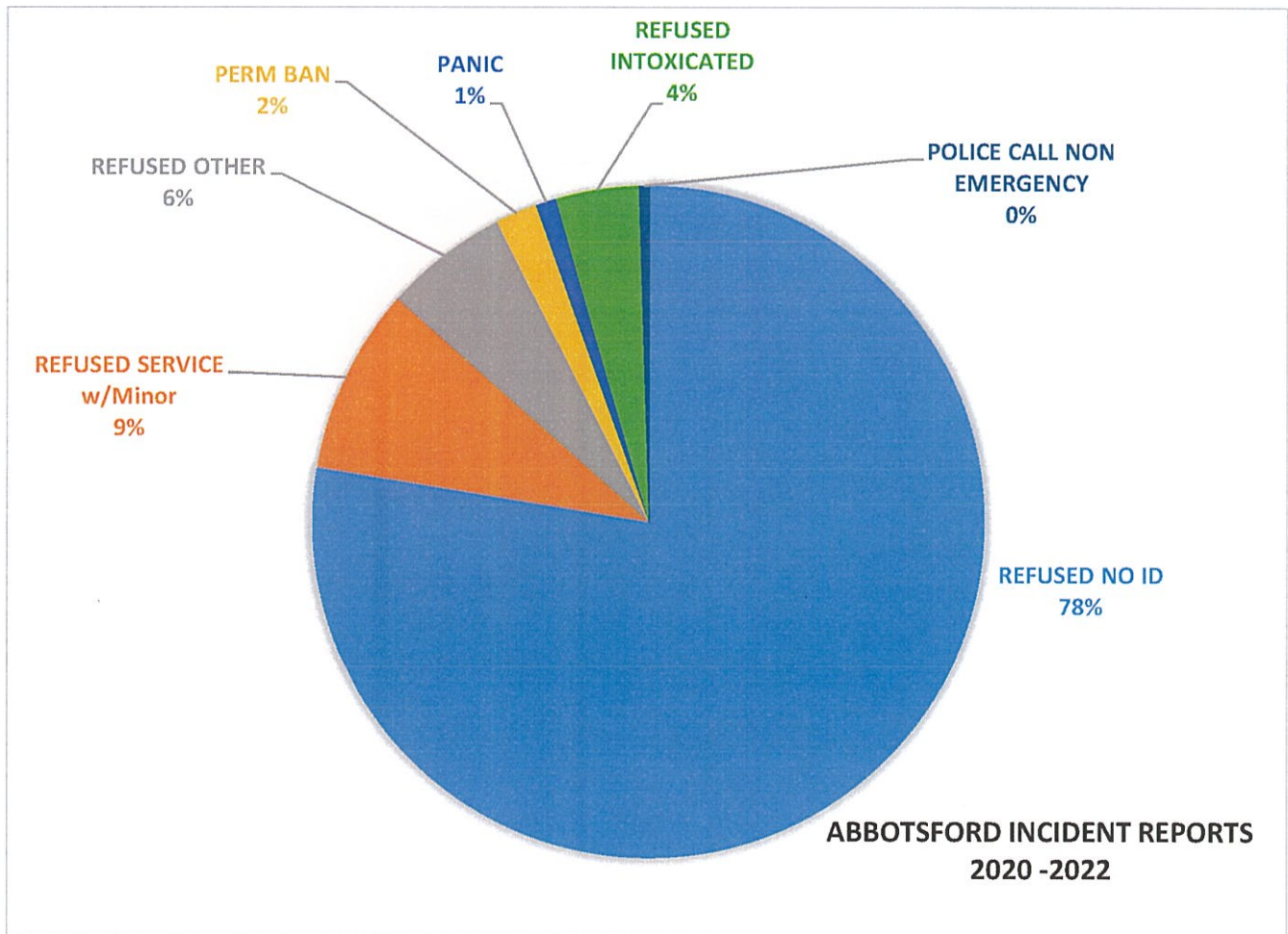

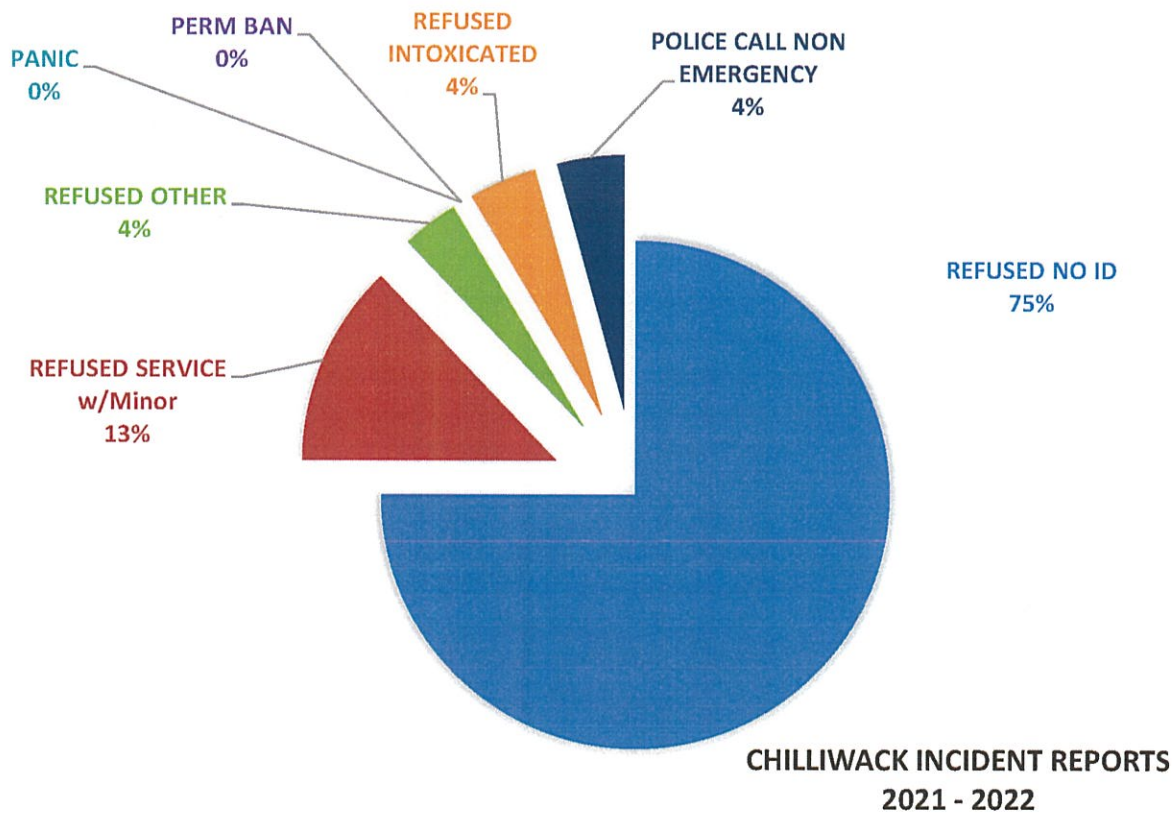

17. SECURITY RESPONSE

There is no uniform security patrolling mountain square plaza in Whistler. Owners of This is Cannabis advised they are planning to relocate the current Chilliwack store manager to whistler, who will set up primary residence in whistler and handle all issues including after hours alarm calls for the whistler store by verifying all alarms remotely and initiating police response if required.

The Royal Canadian Mounted Police (RCMP) are located at 4315 Blackcomb Way, Whistler, BC V0N 1B4 and is a 450m walk to mountain square plaza. RCMP do routinely patrol by car and on foot retail areas including mountain square plaza throughout the day and evening. This proximity allows ideal police response to any duress or emergencies calls to attend within minutes.

Recommendation: Designated staff must be able to verify in “real time” all after hours alarm calls by accessing security cameras remotely and initiate police response if required.

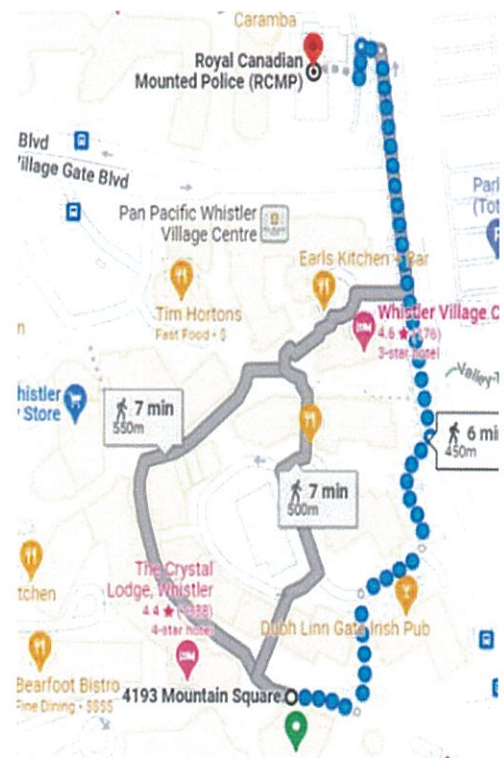

18. PROTECTING YOUTH - IMPACT ON SURROUNDING AREA

The proposed location at 4193 Mountain Square Plaza for This is Cannabis is not in close proximity to any of the local schools in Whistler. RMOV has determined for TUP retail cannabis a 300 meter safe buffer zones for schools, different jurisdictions have proposed different buffers. Alberta will require a distance of 100 metres, while Vancouver (which has determined its own distance municipally) has proposed a 300-metre buffer. As illustrated below the proposed This is Cannabis store is well out of any legacy determined buffer zones.

| SCHOOL | DISTANCE TO 4193 MOUNTAIN SQUARE |
|---|----------------------------------|
| Whistler School (Software Development) 4335 Blackcomb Way | 550m |
| Myrtle Philip Community School 6195 Lorimer Rd | 2 km |
| Whistler Secondary School 8000 Alpine Way | 4.6 km |
| Whistler Waldorf School 7324 Kirkpatrick Way | 4.96 km |
| Spring Creek Community School 1509 Spring Creek Dr | 6.9 km |
| École La Passerelle 1509 Spring Creek Dr | 7.2 km |

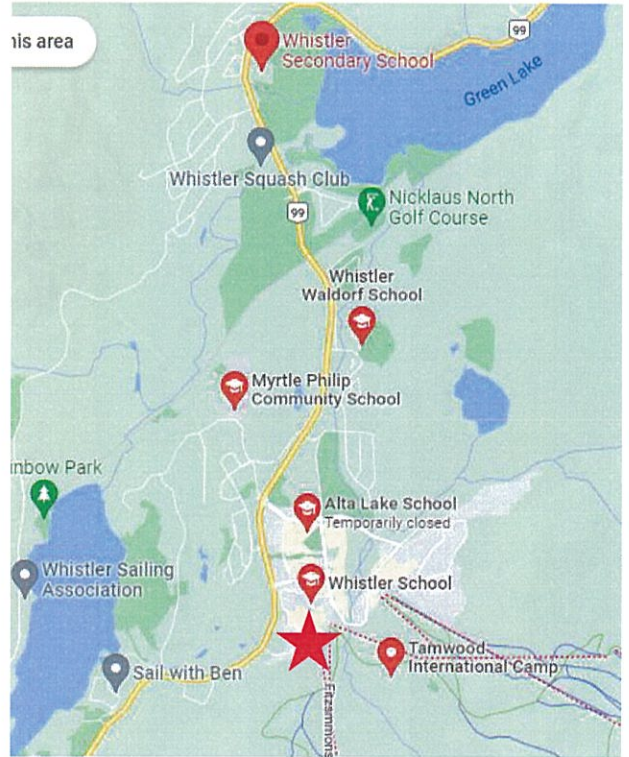

Proposed store exceeds all known separation distance as measured as the crow flies from the center point of the main entrance of the cannabis retail store to the nearest property line.

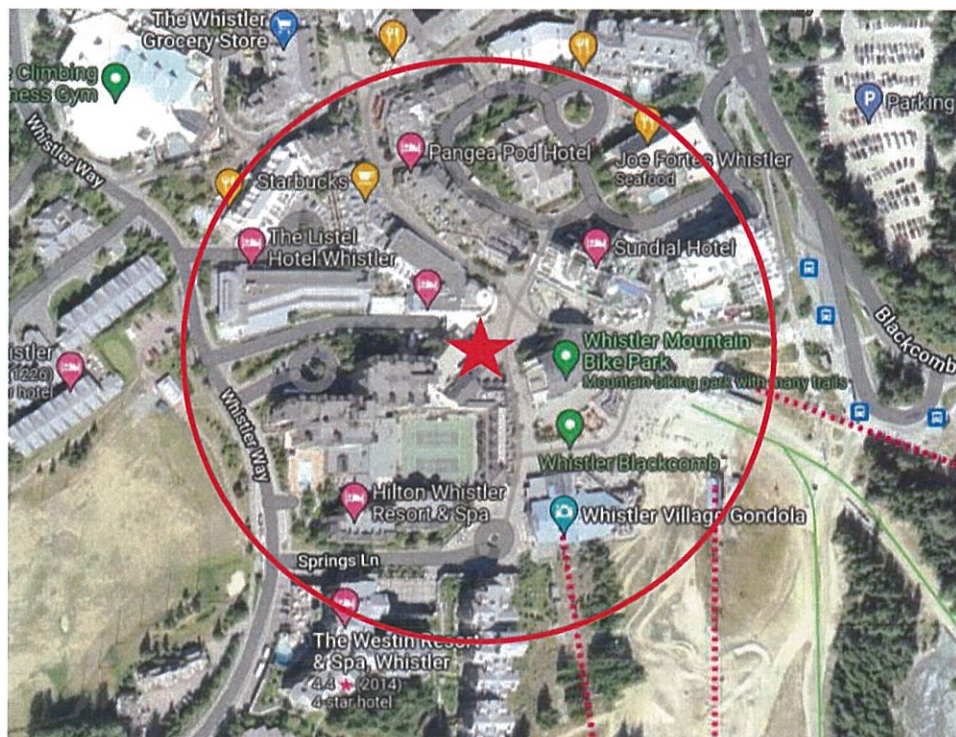

Paladin Risk Director Michael Langlois interviewed Sergeant Bal SIDHU from the RCMP community Policing office on May 19, 2022, to determine if he had seen any increase in crime rates involving theft, break an enter or armed robbery in particular any issues with youth or vulnerable sectors, specifically around jurisdictions where cannabis retail stores are present. He advised that from what he could tell “there was very minimal impact on crime in areas where cannabis retail was present.” He also advised he was “not aware of any duress calls to date being placed for police response in the cannabis sector locally and only a handful of petty theft calls from Surrey and Vancouver.” This information further supports that the introduction of Cannabis retail does not appear to have a negative influence or increase the opportunity for crime in areas where cannabis retail is present.

OPINION

It is the professional opinion of Paladin Risk that This Is Cannabis meets and exceeds all criteria for Crime Prevention Through Environmental Design (CPTED), When taken in consideration of the demographic, residential and commercial usage for real estate in the surrounding area, it is the professional opinion of Paladin Risk that This Is Cannabis will have no detrimental effect on the area, as demonstrated within this report and by design and clearly demonstrated by its existing stores.

19. LIGHTING

The plaza and has a great deal of pedestrian traffic both during the day and tapering off into the evening. The front and side hallway of the store was well lit at night including many light sources from surrounding retail stores and LED light poles located throughout the plaza.

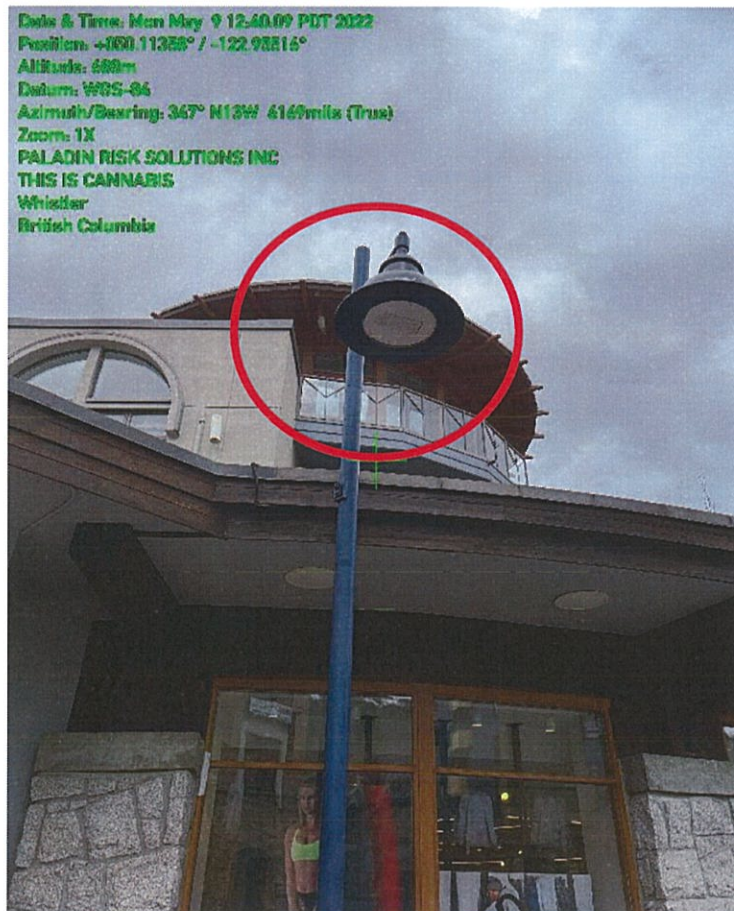

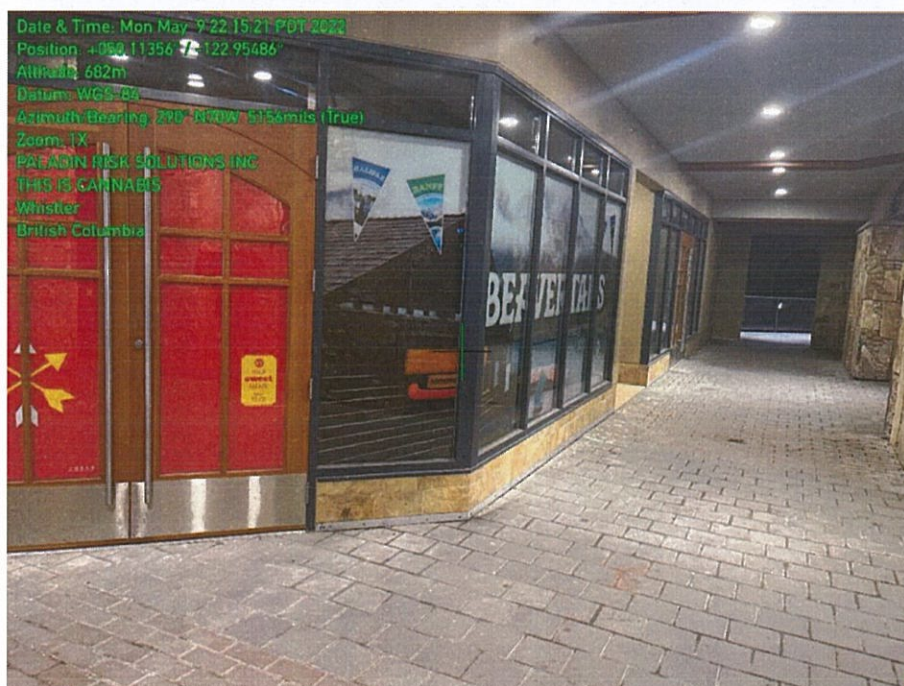

Corridors were well lit at night including many light sources from surrounding retail stores.

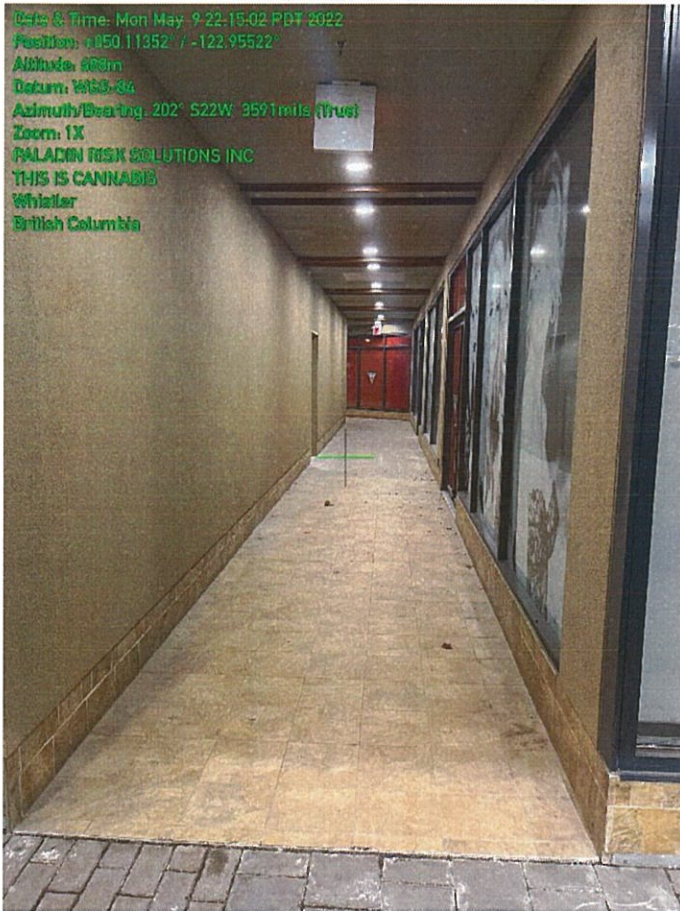

Main entry and adjacent hallway well lit with ceiling pot lights

20. EXECUTIVE SUMMARY

This Security review was requested by This Is Cannabis to illustrate to the Regional Municipality of Whistler (RMOW) their commitment to meeting and exceeding Provincial cannabis legislation governing physical security requirements, by retaining a 3rd party security expert to facilitate security risk assessments of their stores. These assessments are founded on best practice CPTED principles, industry standard references such as the ASIS General Security Risk Assessment (GSRA) Guideline, best practices, acquired knowledge, and the assessor's professional experience regarding physical security requirements and target hardening of their retail stores.

This is Cannabis is committed to demonstrating sound retail practices supporting the Whistler Official Community Plan (OCP) policy framework including upholding the resort experience, while balancing community and guest demand with community safety and a family-friendly environment with focus on:

- Protecting youth
- Limiting proliferation
- Exceeding provincial security requirements to discourage robbery, theft and break and enter

This assessment should not be considered exhaustive in nature and was specific to the physical security vulnerabilities, as they pertain to staff, tenants, public safety, existing security systems and adequacy to support security with mitigating site vulnerabilities from an external point of view.

Paladin Risk has provided detailed observations and recommendations for all primary physical security principles in this report, access control, alarm, lighting, CCTV, policy and procedures and security response mechanisms.

The owners have committed to implementation of all the recommended security measures as defined in this assessment, by doing so achieving an industry best practice rating in all scored security mechanisms. This Is Cannabis is and has demonstrated that it is committed to the protection of youth, students, and vulnerable demographics, with further consideration to the guiding principles of RMOW council policy G-27.

4.0 GUIDING PRINCIPLES

The principles below guided the Cannabis Retail Policy creation and are the foundation of this Council policy. The following guiding principles were developed from existing RMOW plans and policies and are recommended to be considered in evaluation of potential cannabis retail applications along with the locational guidelines in 5.1 and the evaluation criteria specified in 5.2:

- Support a thriving and diverse economy.
- Reinforce Whistler's mountain community character.
- Promote community and social well-being.
- Establish a transparent and efficient process.
- Balance community and visitor demand with community safety and Whistler's family-friendly environment; and
- Support and advance reconciliation and economic opportunities with the Skw̓w̓w̓7mesh and Lilwat7úl people.

The owners of This is Cannabis have met and exceeded all legislative and ethical requirements in their existing stores. Paladin Risk have audited those existing stores and found that the physical security, staff training, policies and procedures are professional, consistent, and strictly applied. No evidence has been found that their stores have any negative impact on the surrounding youth/sensitive demographics in those areas.

In my opinion This Is Cannabis will make a secure, safe, and prosperous addition to the retail environment of the Regional Municipality of Whistler (RMOW).

As submitted,



*Local Experts.
Global Experience.*

Michael Langlois, CPP
Director, Risk

Paladin Risk Solutions Inc.

C. 604-362-5768

mlanglois@paladinrisksolutions.com

201 - 3001 Wayburne Drive, Burnaby BC V5G 4W3

paladinrisksolutions.com



DISCLAIMER

This report is confidential and is intended to be used solely by the client for whom this report was prepared and to whom it is addressed for information purposes only and for no other purpose, except as may be expressly stated herein. This report may not be copied, reproduced, disseminated, distributed, or otherwise made available to any third party, in whole or in part, without the express written consent of Paladin Risk Solutions Inc. which consent may be withheld for any reason. In preparing this report, Paladin Risk Solutions Inc. has used its professional care and diligence and has endeavored to include in this report and to base its analysis upon information that it believes to be relevant to the purposes of this report.



GENERATED FOR: PALADIN RISK SOLUTIONS INC.

SITE NAME: THIS IS CANNABIS

ADDRESS: 4293 MOUNTAIN SQUARE
WHISTLER, BC V0N 1B4

CREATION DATE: NOVEMBER 08, 2022

CRIMECAST® PREMIUM REPORT

CRIMECAST® Reports indicate the likelihood of crime and loss occurring at any address in the United States, Canada, Mexico, and the United Kingdom. Each report includes CAP Scores designating the risk of crime as well as detailed maps depicting those risks within a defined radius around each location.



2023 CAP INDEX® SCORES

MAX-1: 30

MAX-3: 32



REPORT COMPONENTS

SCORING METHODOLOGY

This area indicates the scoring methodology being used. Reference the Appendix page for an explanation of the various methodologies.

CAP SCORES

The **National CAP Index® Score** indicates the overall risk of crime at the address.

The report also includes nine specific CAP Scores pertaining to **Crimes Against Persons** and **Crimes Against Property**.

CRIMECAST® MAPS

The **Site Map** shows the **Census Area Score** for each "neighborhood" surrounding a given location. The Site Map helps depict the potential origin of criminal activity occurring at the location.

There are over 23,000 census areas in Canada. Each one typically contains over 1,000 residents with similar socioeconomic characteristics.

Every census area is assigned a numeric risk score and a corresponding risk shading.

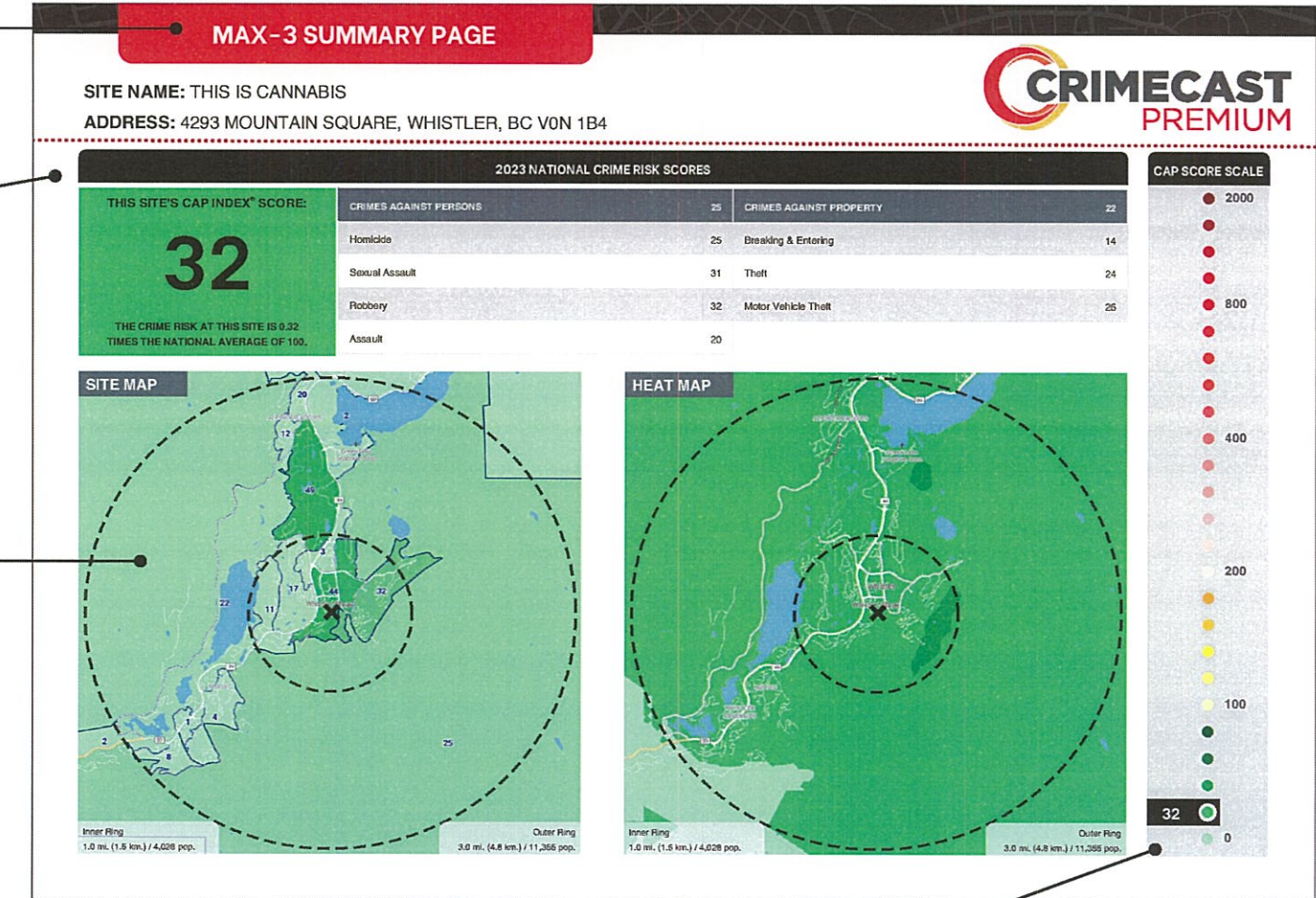

The **Heat Map** provides an alternative view of the risk of crime within the map window. CRIMECAST® Heat Maps are developed by calculating the CAP Index® Scores for every point on the map and then shading its corresponding risk level.

CAP SCORE SCALE

CAP Scores range from 0 to 2000, with 0 representing the lowest risk and 2000 the highest; 100 is average. A score of 600 is 6 times the National Average, and a score of 25 indicates a risk that is 1/4 of the National Average.

SITE NAME: THIS IS CANNABIS

ADDRESS: 4293 MOUNTAIN SQUARE, WHISTLER, BC V0N 1B4

2023 NATIONAL CRIME RISK SCORES

THIS SITE'S CAP INDEX® SCORE:

30

THE CRIME RISK AT THIS SITE IS 0.3 TIMES THE NATIONAL AVERAGE OF 100.

| CRIMES AGAINST PERSONS | 24 | CRIMES AGAINST PROPERTY | 22 |
|------------------------|----|-------------------------|----|
| Homicide | 24 | Breaking & Entering | 11 |
| Sexual Assault | 26 | Theft | 24 |
| Robbery | 32 | Motor Vehicle Theft | 25 |
| Assault | 19 | | |

CAP SCORE SCALE

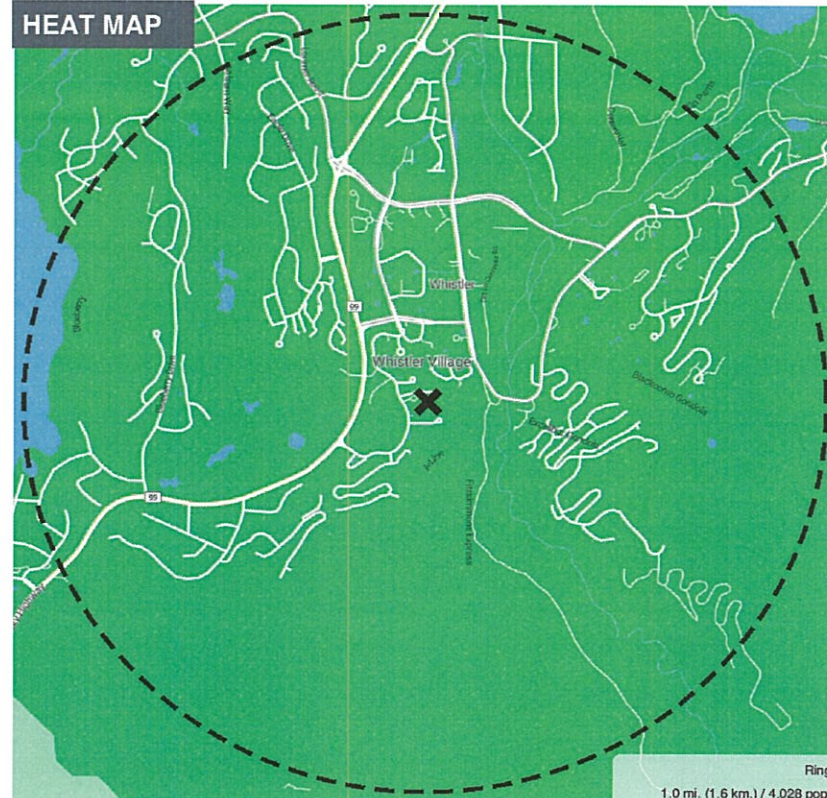
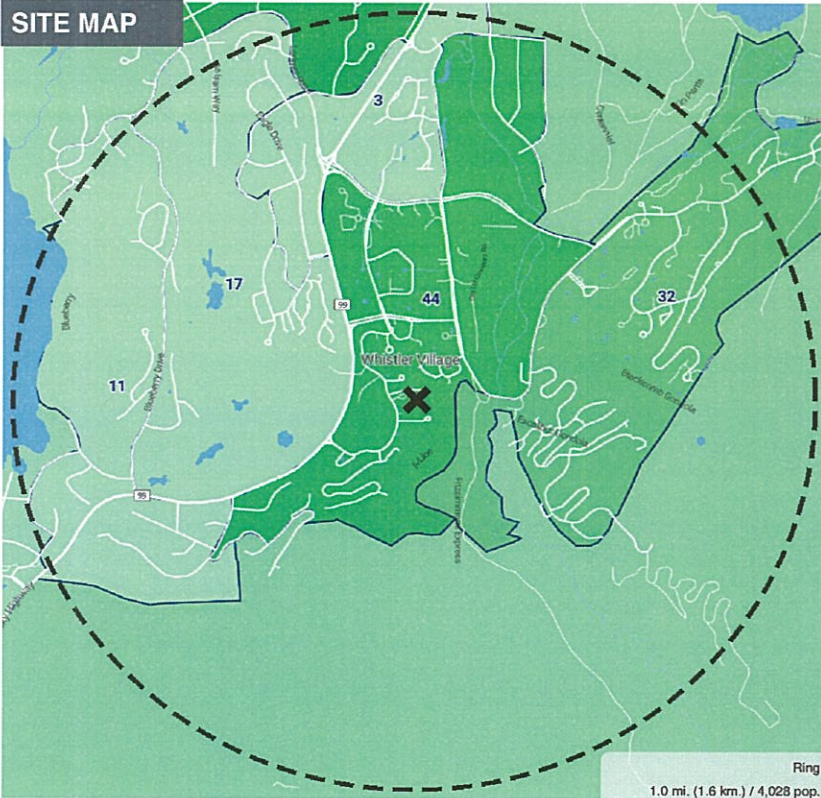
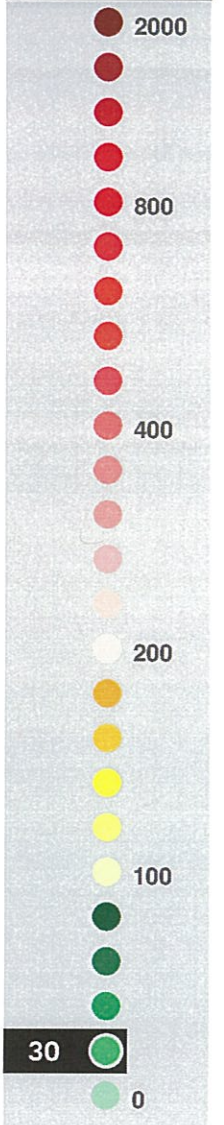

MAX-1 SITE MAP

SITE NAME: THIS IS CANNABIS

ADDRESS: 4293 MOUNTAIN SQUARE, WHISTLER, BC V0N 1B4



2023 NATIONAL CRIME RISK SCORES

THIS SITE'S CAP INDEX® SCORE:

30

THE CRIME RISK AT THIS SITE IS 0.3 TIMES THE NATIONAL AVERAGE OF 100.

CRIMES AGAINST PERSONS 24

| | |
|----------------|----|
| Homicide | 24 |
| Sexual Assault | 26 |
| Robbery | 32 |
| Assault | 19 |

CRIMES AGAINST PROPERTY 22

| | |
|---------------------|----|
| Breaking & Entering | 11 |
| Theft | 24 |
| Motor Vehicle Theft | 25 |

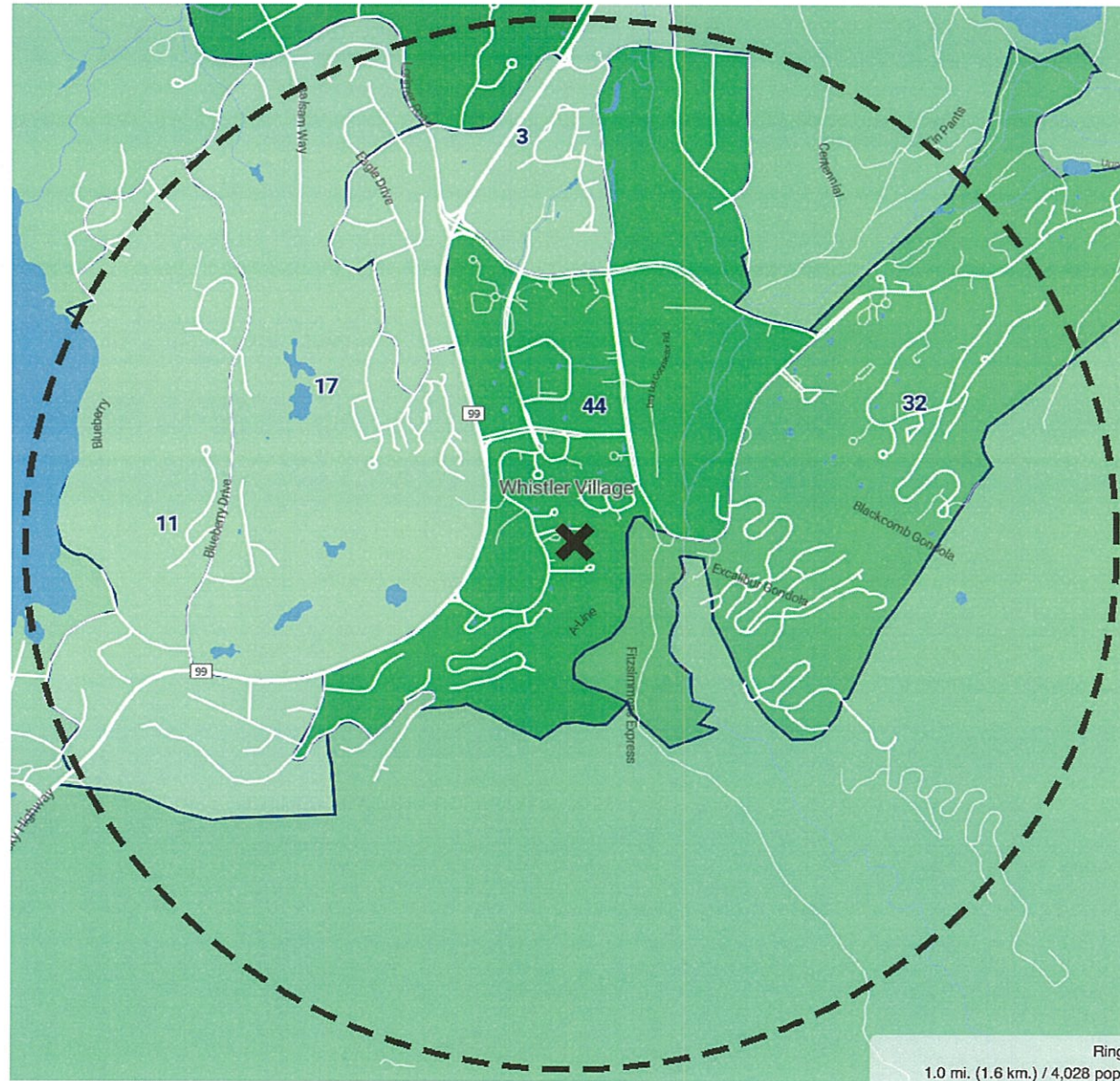

CAP SCORE SCALE

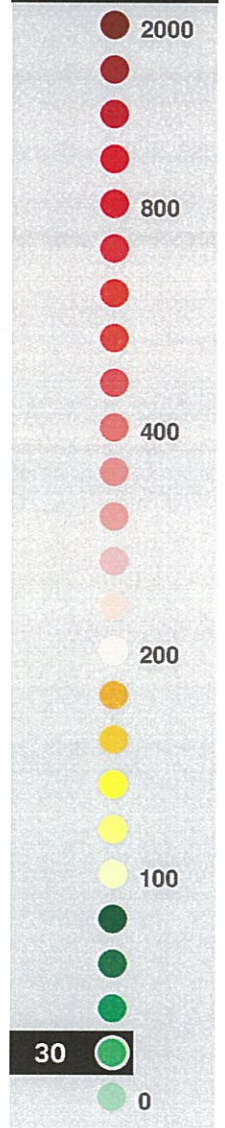

Creation Date: November 08, 2022
Database Year: 2023

CRIMECAST and CAP Index are registered trademarks of CAP Index, Inc. Please note terms and conditions as presented on <https://capindex.com/terms-conditions>. ©2022 CAP Index, Inc. All rights reserved.

MAX-1 HEAT MAP

SITE NAME: THIS IS CANNABIS

ADDRESS: 4293 MOUNTAIN SQUARE, WHISTLER, BC V0N 1B4



2023 NATIONAL CRIME RISK SCORES

THIS SITE'S CAP INDEX® SCORE:

30

THE CRIME RISK AT THIS SITE IS 0.3 TIMES THE NATIONAL AVERAGE OF 100.

CRIMES AGAINST PERSONS 24

| | |
|----------------|----|
| Homicide | 24 |
| Sexual Assault | 26 |
| Robbery | 32 |
| Assault | 19 |

CRIMES AGAINST PROPERTY 22

| | |
|---------------------|----|
| Breaking & Entering | 11 |
| Theft | 24 |
| Motor Vehicle Theft | 25 |



CAP SCORE SCALE

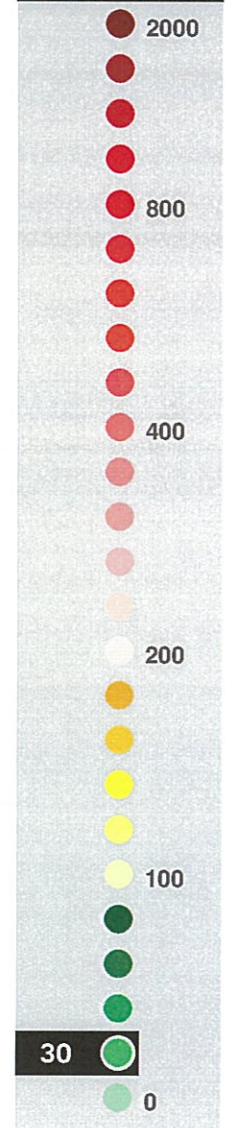

Creation Date: November 08, 2022
Database Year: 2023

CRIMECAST and CAP Index are registered trademarks of CAP Index, Inc. Please note terms and conditions as presented on <https://capindex.com/terms-conditions>. ©2022 CAP Index, Inc. All rights reserved.

MAX-1 SCORE SUMMARY

SITE NAME: THIS IS CANNABIS

ADDRESS: 4293 MOUNTAIN SQUARE, WHISTLER, BC V0N 1B4



The Score Summary includes a total of 90 risk scores - 10 for each of 3 geographic levels and three time periods. The National Scores provide the site's risk in comparison to all of Canada broken down by crime category, while the Province Scores compare the site to the province averages and the Census Subdivision Scores to the census subdivision averages. Past, Current, and Projected risk scores are provided to allow for trending.

| GEOGRAPHIC LEVEL | CANADA | | | BRITISH COLUMBIA / COLOMBIE-BRITANNIQUE | | | WHISTLER | | |
|--------------------------------|-----------|--------------|----------------|---|--------------|----------------|------------|--------------|----------------|
| | PAST 2016 | CURRENT 2023 | PROJECTED 2028 | PAST 2016 | CURRENT 2023 | PROJECTED 2028 | PAST 2016 | CURRENT 2023 | PROJECTED 2028 |
| CAP Index® Score | 30 | 30 | 30 | 37 | 36 | 36 | 145 | 149 | 151 |
| CRIMES AGAINST PERSONS | 25 | 24 | 24 | 32 | 30 | 29 | 151 | 153 | 154 |
| Homicide | 25 | 24 | 24 | 32 | 30 | 29 | 151 | 153 | 154 |
| Sexual Assault | 25 | 26 | 27 | 32 | 33 | 33 | 114 | 117 | 118 |
| Robbery | 33 | 32 | 31 | 39 | 38 | 36 | 166 | 169 | 171 |
| Assault | 21 | 19 | 19 | 28 | 24 | 24 | 158 | 156 | 160 |
| CRIMES AGAINST PROPERTY | 21 | 22 | 23 | 32 | 32 | 32 | 144 | 143 | 142 |
| Breaking & Entering | 9 | 11 | 11 | 14 | 16 | 15 | 73 | 83 | 76 |
| Theft | 24 | 24 | 25 | 38 | 36 | 35 | 164 | 155 | 156 |
| Motor Vehicle Theft | 24 | 25 | 26 | 34 | 34 | 34 | 129 | 130 | 128 |



SITE NAME: THIS IS CANNABIS

ADDRESS: 4293 MOUNTAIN SQUARE, WHISTLER, BC V0N 1B4

2023 NATIONAL CRIME RISK SCORES

THIS SITE'S CAP INDEX® SCORE:

32

THE CRIME RISK AT THIS SITE IS 0.32
TIMES THE NATIONAL AVERAGE OF 100.

| CRIMES AGAINST PERSONS | 25 | CRIMES AGAINST PROPERTY | 22 |
|------------------------|----|-------------------------|----|
| Homicide | 25 | Breaking & Entering | 14 |
| Sexual Assault | 31 | Theft | 24 |
| Robbery | 32 | Motor Vehicle Theft | 26 |
| Assault | 20 | | |

CAP SCORE SCALE

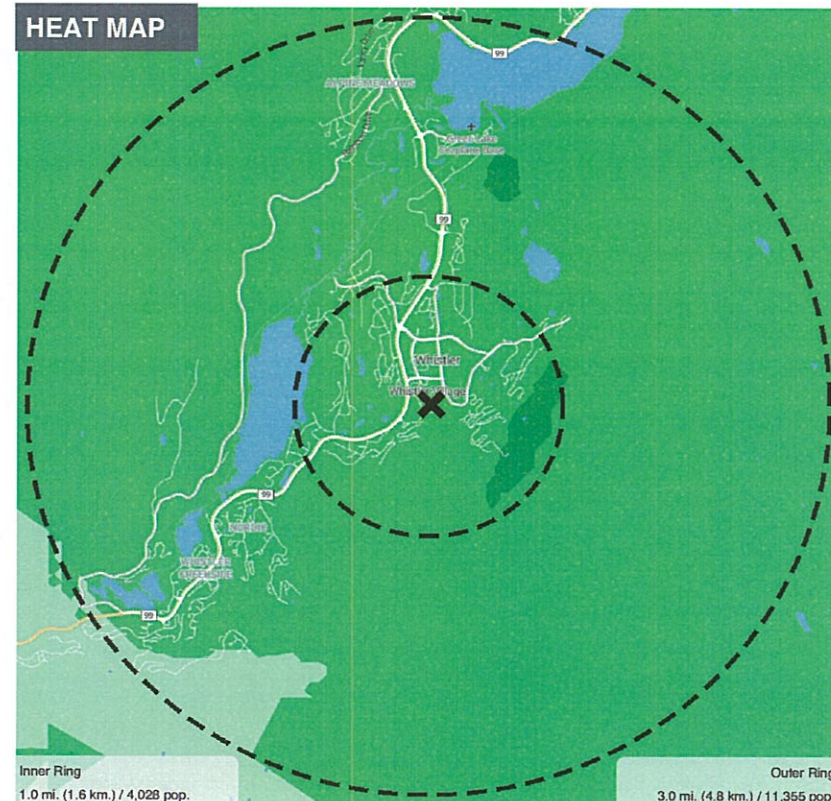
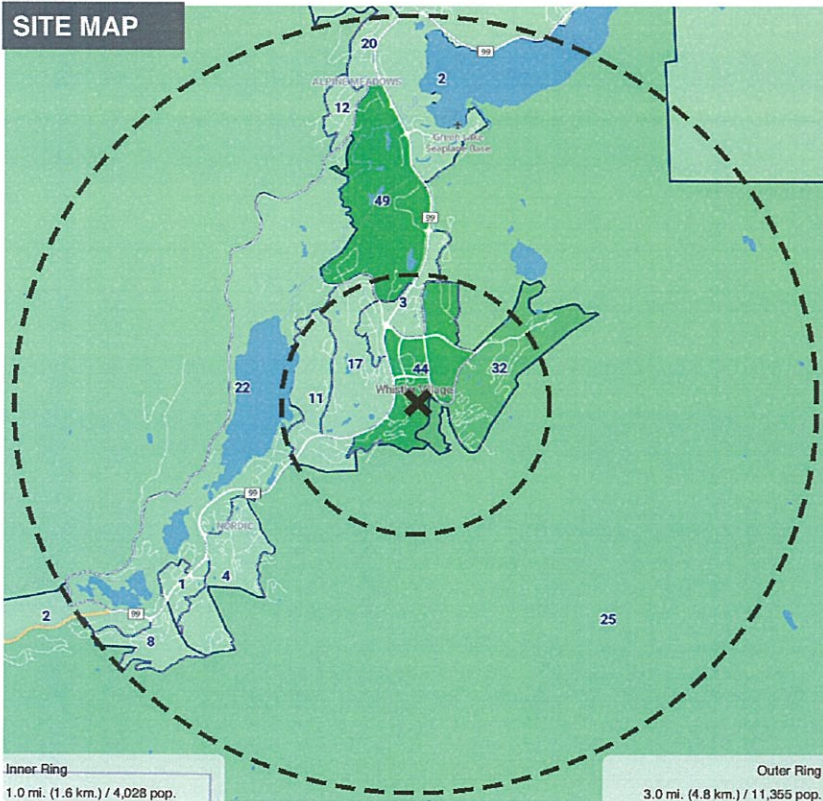
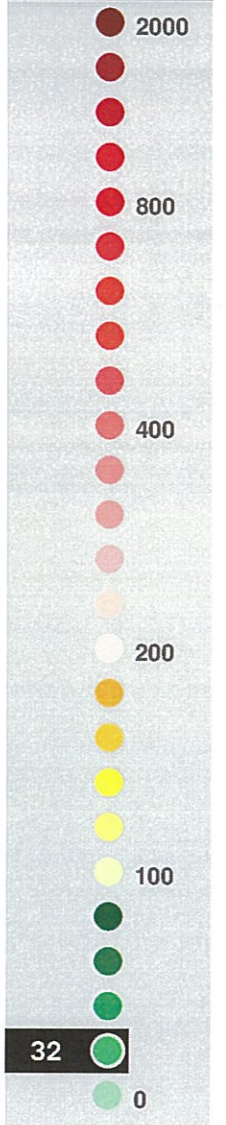

MAX-3 SITE MAP

SITE NAME: THIS IS CANNABIS

ADDRESS: 4293 MOUNTAIN SQUARE, WHISTLER, BC V0N 1B4



2023 NATIONAL CRIME RISK SCORES

THIS SITE'S CAP INDEX® SCORE:

32

THE CRIME RISK AT THIS SITE IS 0.32 TIMES THE NATIONAL AVERAGE OF 100.

| CRIMES AGAINST PERSONS | |
|-------------------------|----|
| Homicide | 25 |
| Sexual Assault | 31 |
| Robbery | 32 |
| Assault | 20 |
| CRIMES AGAINST PROPERTY | |
| Breaking & Entering | 14 |
| Theft | 24 |
| Motor Vehicle Theft | 26 |

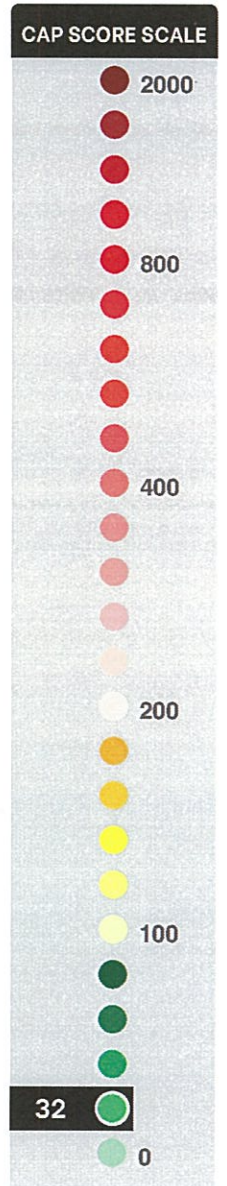
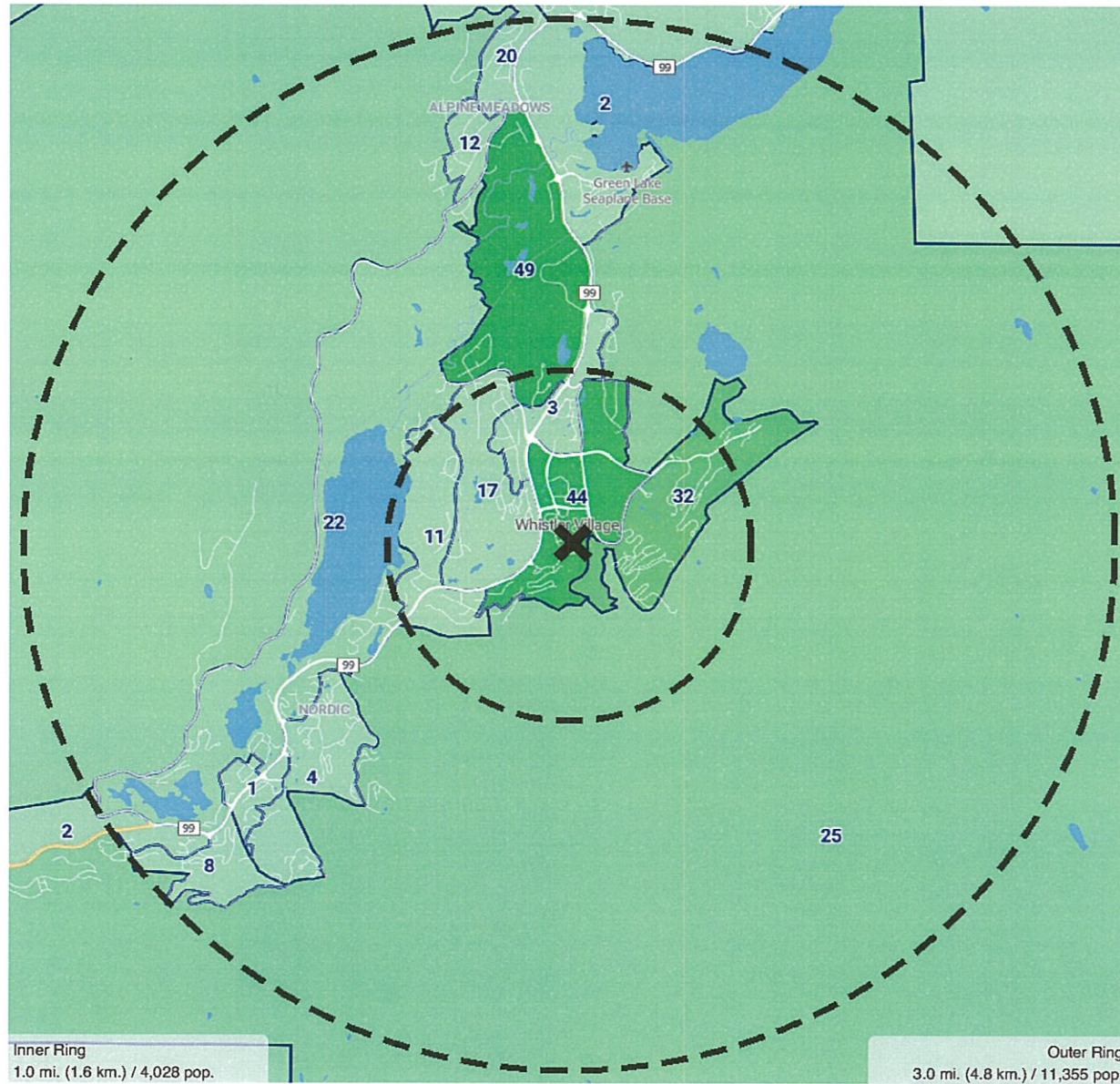

Creation Date: November 08, 2022
Database Year: 2023

CRIMECAST and CAP Index are registered trademarks of CAP Index, Inc. Please note terms and conditions as presented on <https://capindex.com/terms-conditions>. ©2022 CAP Index, Inc. All rights reserved.

SITE NAME: THIS IS CANNABIS

ADDRESS: 4293 MOUNTAIN SQUARE, WHISTLER, BC V0N 1B4

2023 NATIONAL CRIME RISK SCORES

THIS SITE'S CAP INDEX® SCORE:

32

THE CRIME RISK AT THIS SITE IS 0.32 TIMES THE NATIONAL AVERAGE OF 100.

CRIMES AGAINST PERSONS 25

Homicide 25

Sexual Assault 31

Robbery 32

Assault 20

CRIMES AGAINST PROPERTY 22

Breaking & Entering 14

Theft 24

Motor Vehicle Theft 26

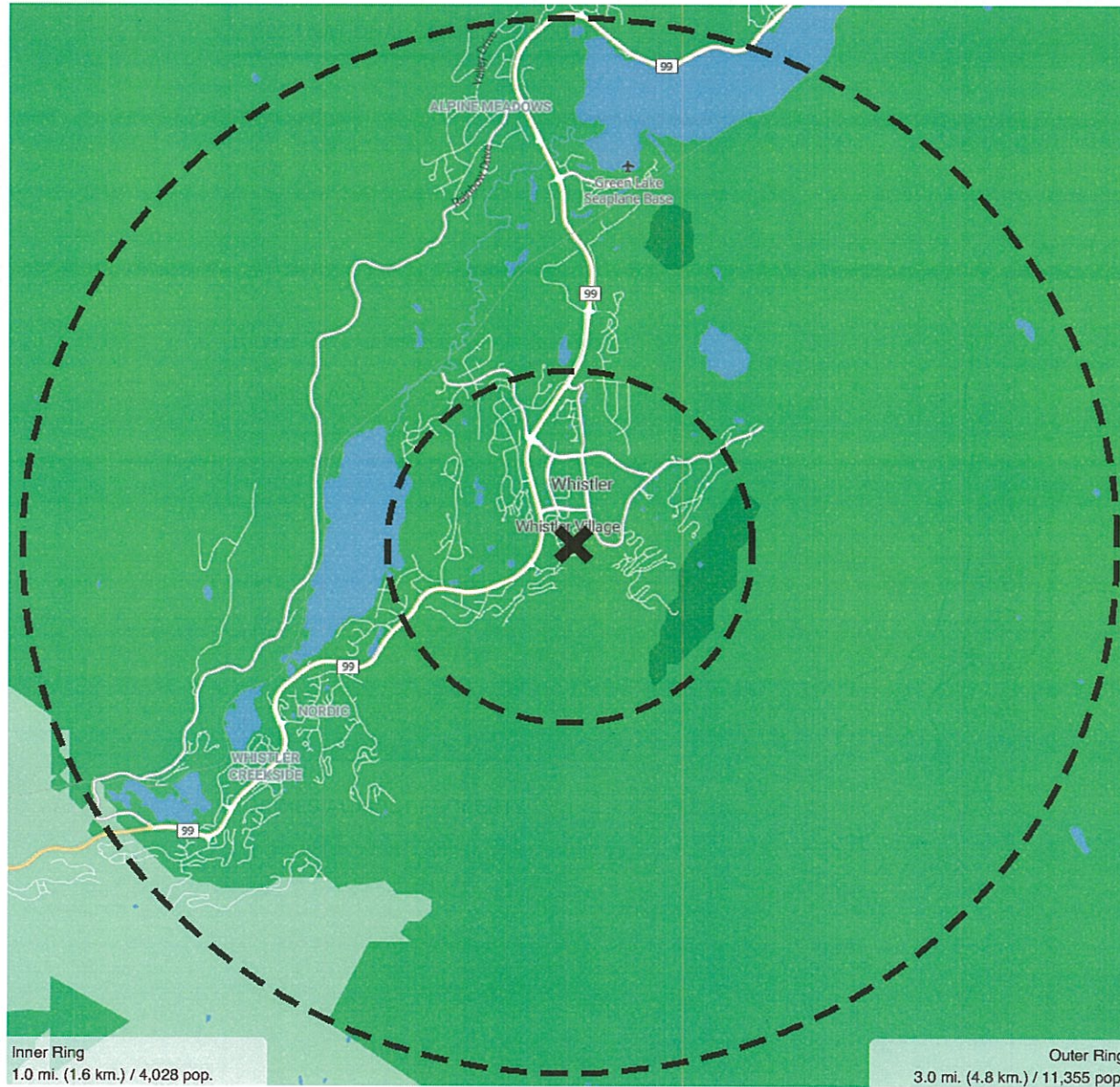

CAP SCORE SCALE

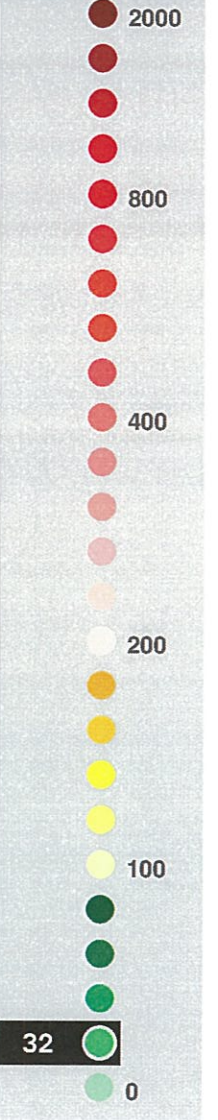

MAX-3 SCORE SUMMARY

SITE NAME: THIS IS CANNABIS

ADDRESS: 4293 MOUNTAIN SQUARE, WHISTLER, BC V0N 1B4



The Score Summary includes a total of 90 risk scores - 10 for each of 3 geographic levels and three time periods. The National Scores provide the site's risk in comparison to all of Canada broken down by crime category, while the Province Scores compare the site to the province averages and the Census Subdivision Scores to the census subdivision averages. Past, Current, and Projected risk scores are provided to allow for trending.

| GEOGRAPHIC LEVEL | CANADA | | | BRITISH COLUMBIA / COLOMBIE-BRITANNIQUE | | | WHISTLER | | |
|--------------------------------|-----------|--------------|----------------|---|--------------|----------------|------------|--------------|----------------|
| | PAST 2016 | CURRENT 2023 | PROJECTED 2028 | PAST 2016 | CURRENT 2023 | PROJECTED 2028 | PAST 2016 | CURRENT 2023 | PROJECTED 2028 |
| CAP Index® Score | 32 | 32 | 31 | 39 | 39 | 37 | 154 | 159 | 157 |
| CRIMES AGAINST PERSONS | 26 | 25 | 25 | 33 | 31 | 30 | 157 | 159 | 160 |
| Homicide | 26 | 25 | 25 | 33 | 31 | 30 | 157 | 159 | 160 |
| Sexual Assault | 30 | 31 | 31 | 39 | 39 | 38 | 137 | 140 | 136 |
| Robbery | 34 | 32 | 31 | 40 | 38 | 36 | 171 | 169 | 171 |
| Assault | 21 | 20 | 19 | 28 | 25 | 24 | 158 | 164 | 160 |
| CRIMES AGAINST PROPERTY | 21 | 22 | 23 | 32 | 32 | 32 | 144 | 143 | 142 |
| Breaking & Entering | 12 | 14 | 15 | 18 | 20 | 21 | 98 | 106 | 104 |
| Theft | 24 | 24 | 25 | 38 | 36 | 35 | 164 | 155 | 156 |
| Motor Vehicle Theft | 24 | 26 | 27 | 34 | 36 | 35 | 129 | 135 | 133 |



POINT OF INTEREST (POI) DATA

SITE NAME: THIS IS CANNABIS

ADDRESS: 4293 MOUNTAIN SQUARE, WHISTLER, BC V0N 1B4



This page helps to identify potential targets, threats, or other points of interest (POIs) in a site's vicinity and is based on information supplied by external data providers. This assessment focuses on select POI categories that fall within the general headings of infrastructure, transportation, and attractions.

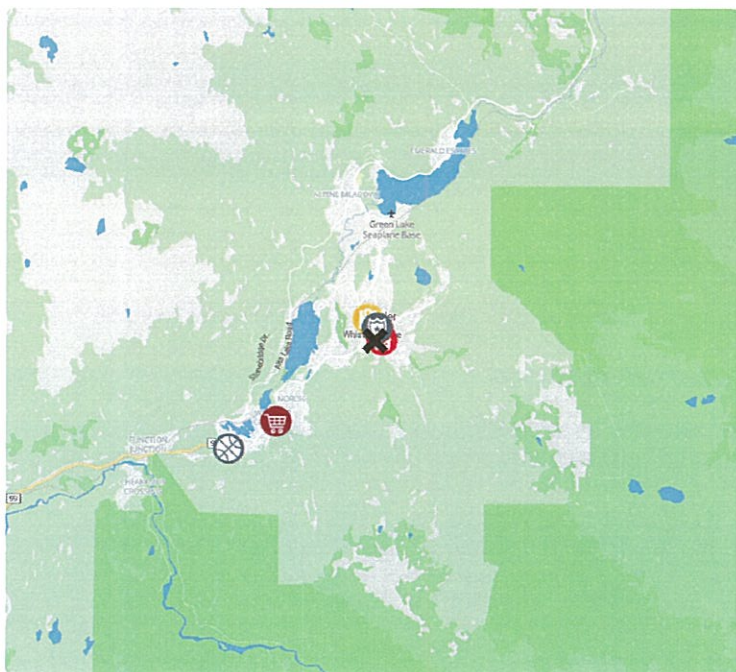

X indicates the current site

| TYPE | CLOSEST SITE | DISTANCE IN: | |
|-----------------------|----------------------|--------------|-----|
| | | MI. | KM. |
| Attractions | | | |
| Shopping | Whistler, BC V0N 1B2 | 2.0 | 3.2 |
| Sports Complex | Whistler, BC V0N 1B2 | 2.9 | 4.7 |
| Infrastructure | | | |
| Fire Station | Whistler, BC V0N 1B4 | 0.2 | 0.3 |
| Hospital | Whistler, BC V0N 1B4 | 0.4 | 0.6 |
| Police Station | Whistler, BC V0N 1B4 | 0.2 | 0.3 |
| Transportation | | | |
| Bus Station | Whistler, BC V0N 1B4 | 0.2 | 0.3 |

This information is based on point of interest data supplied by external providers. Although these sources are considered highly reliable, CAP Index, Inc. is not able to vouch for their completeness or accuracy. Nevertheless, it must be assumed that this information is in fact complete and accurate.



Creation Date: November 08, 2022
Database Year: 2023

CRIMECAST and CAP Index are registered trademarks of CAP Index, Inc. Please note terms and conditions as presented on <https://capindex.com/terms-conditions>. ©2022 CAP Index, Inc. All rights reserved.

ABOUT CRIMECAST SCORING

THE CAP INDEX® SCORING SYSTEM

The CAP Index® Scoring System uses sophisticated forecasting techniques that combine demographic and business statistics with crime and loss data to calculate crime risk. The foundation of our forecasting approach is the “Social Disorganization Theory,” which asserts that higher degrees of social discord in a neighborhood tend to correlate with higher levels of crime.



SCORING METHODOLOGIES

CAP Scores for a specific business application are generated using one of four CAP Index® Scoring Methodologies. These scoring methodologies account for the fact that perpetrators often travel varying distances to commit crimes (the “journey to crime”) depending on the target. The scoring methodologies also consider the nature and attractiveness of different types of targets for different types of crimes. Each methodology designates a progressively larger “sphere of influence” that is used to assess the risk of crime. Each sphere is defined by a maximum geographic radius or a population threshold. These spheres have different components that drive the overall crime risk score. The inner part of the sphere focuses on the nearest neighborhoods and receives the higher percentage of the weight. The outer part of the sphere considers more distant avenues of vulnerability and receives the remaining percentage of the weight.

| Scoring Methodology | Outer Ring / Population for Assessment | Weight | Inner Ring / Population for Assessment | Weight |
|---------------------|---|--------|--|--------|
| MAX-1 | 1 mile (1.6 km.) or 25,000 people | N/A | 1 mile (1.6 km.) or 25,000 people | 100% |
| MAX-3 | 3 miles (4.8 km.) or 100,000 people | 20% | 1 mile (1.6 km.) or 25,000 people | 80% |
| MAX-6 | 6 miles (9.7 km.) or 400,000 people | 20% | 2 miles (3.2 km.) or 100,000 people | 80% |
| MAX-12 | 12 miles (19.3 km.) or 1,600,000 people | 33% | 4 miles (6.4 km.) or 400,000 people | 67% |

CAP SCORE SCALE

CAP Scores range from 0 to 2000, with 0 representing the lowest risk and 2000 the highest; 100 is average. A score of 600 is 6 times the National Average, and a score of 25 indicates a risk that is 1/4 of the National Average.

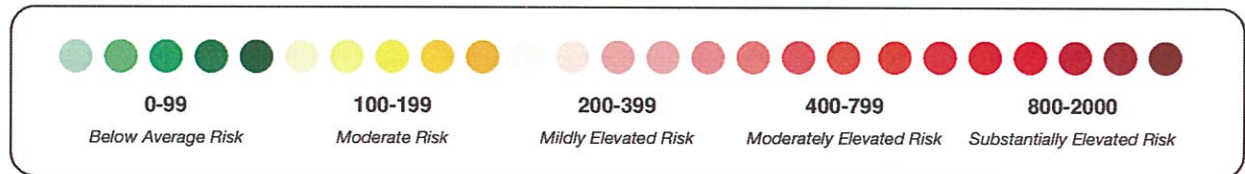

RELIED UPON
BY OVER
80%
OF THE
FORTUNE 100

THE LEADERS IN CRIME RISK FORECASTING

CAP Index empowers organizations to make better-informed decisions throughout the security planning and security management cycle. Whether you are opening a new location, planning security measures for your existing locations, or conducting services off-site, our validated crime risk intelligence will help you create impactful security solutions to protect your customers, employees, assets, and your bottom line.



CRIMECAST® DATA & REPORTS

Quantify and visualize your risk with our detailed, industry-leading, site-specific crime risk reports.



RISK CONSULTING & ANALYTICS

Elevate your security program by having our team of consultants produce a crime risk scoring system tailored to your organization's needs.



TECHNOLOGY, PLATFORMS, & MODULES

Manage your security planning process and loss prevention program from one dashboard.

HOW WE HELP: ASSESS YOUR RISK AND OUTSMART CRIME®



Make your customers, employees, and assets safer



Optimize the return from your security investment



Reduce litigation and avoid adverse judgments



Reduce crime, loss, and claims



Ensure compliance with industry standards



Protect your brand

800.227.7475 | 001.610.903.3000 | capindex.com | askcap@capindex.com



THIS

CANNABIS

CONTEXT PLAN

CONTEXT PLAN

The following maps and photos show distances from the nearest parcel containing a school (Myrtle Philip Community School), adjacent streets, and the TUP area of "The Village" in Whistler with our retail footprint shaded in green. This shop is situated in the Hilton commercial building (CC1 Zone) with no frontage on the village stroll. This location complies with all locational requirements per Cannabis Retail Policy G-27 and Whistler's Zoning and Parking Bylaw.





4293 Mountain Square

- Directions
- Save
- Nearby
- Send to phone
- Share

- 4293 Mountain Square, Whistler, BC V0N 1B4
- 427V+7M Whistler, British Columbia
- Suggest an edit on 4293 Mountain Square
- Add a missing place
- Add your business
- Add a label

Photos



Directory

Whistler Core Climbing ar

Restaurants Hotels Things to do Transit Parking Pharmacies ATMs

Neighbourhood Pub La Brasserie 301

Hot Buns Bakery Hôtel

Beacon Pub & Eatery Joe Fortes Whistler Seafood

Fat Tony's Pizza Pizza · \$ Sundial 4.5 ★ (734) 4-star hotel

Lodge, 104 Il Caminetto Italian · \$\$\$\$ Tesla Destination Charger

Stonesedge Kitchen Starbucks Executive Inn at Whistler Village & Mountain Side 3.9 ★ (431) 3-star hotel

#6 Unit 100 The Crystal Lodge, Whistler 4.4 ★ (1432) 4-star hotel

Whistler Mountain Bike Park

Bearfoot Bistro Fine Dining · \$\$\$\$ Carleton Lodge 4.4 ★ (219) 4-star hotel

The Listel Hotel Whistler 4.1 ★ (523) 3-star hotel The Longhorn Saloon Grill · \$\$

Whistler Ski Lift

Mountain Ln Mountain-biking park with many trails

Whistler Mountain Gondola

Rocky Mountain Chocolate #118-214

Cinnamon Bear Bar & Grille

Fitzsimmons Express Chairlift

Hilton Whistler Resort & Spa 4.2 ★ (1789) 4-star hotel

Whistler Mountain

Springs Ln Springs Ln

The Mountain Club

Gibbons Whistler Boutique Accommodation - Gib...

Grill & Vine Whistler

Whistler Village Gondola

Layers

Google

Map data ©2023 Google Canada Terms Privacy Send feedback 20 m

Point
 Freehand
 Line
 Polygon
 Rectangle
 Clear Selection

Distance
 Area
 Clear

Find Data Measure

- Schools (5)
- ☆ School > ...

School Name: Myrtle Philip Community School
 Education Level: ELEMENTARY
 School Category: BC Public School
 - ☆ School > ...

School Name: Whistler Secondary
 Education Level: SECONDARY
 School Category: BC Public School
 - ☆ School > ...

School Name: Spring Creek Community School
 Education Level: ELEMENTARY
 School Category: BC Public School
 - ☆ School > ...

School Name: Ecole la Passerelle
 Education Level: ELEMENTARY
 School Category: BC Public School
 - ☆ School > ...

School Name: Whistler Waldorf School
 Education Level: ELEMENTARY SECONDARY
 School Category: BC Independent School

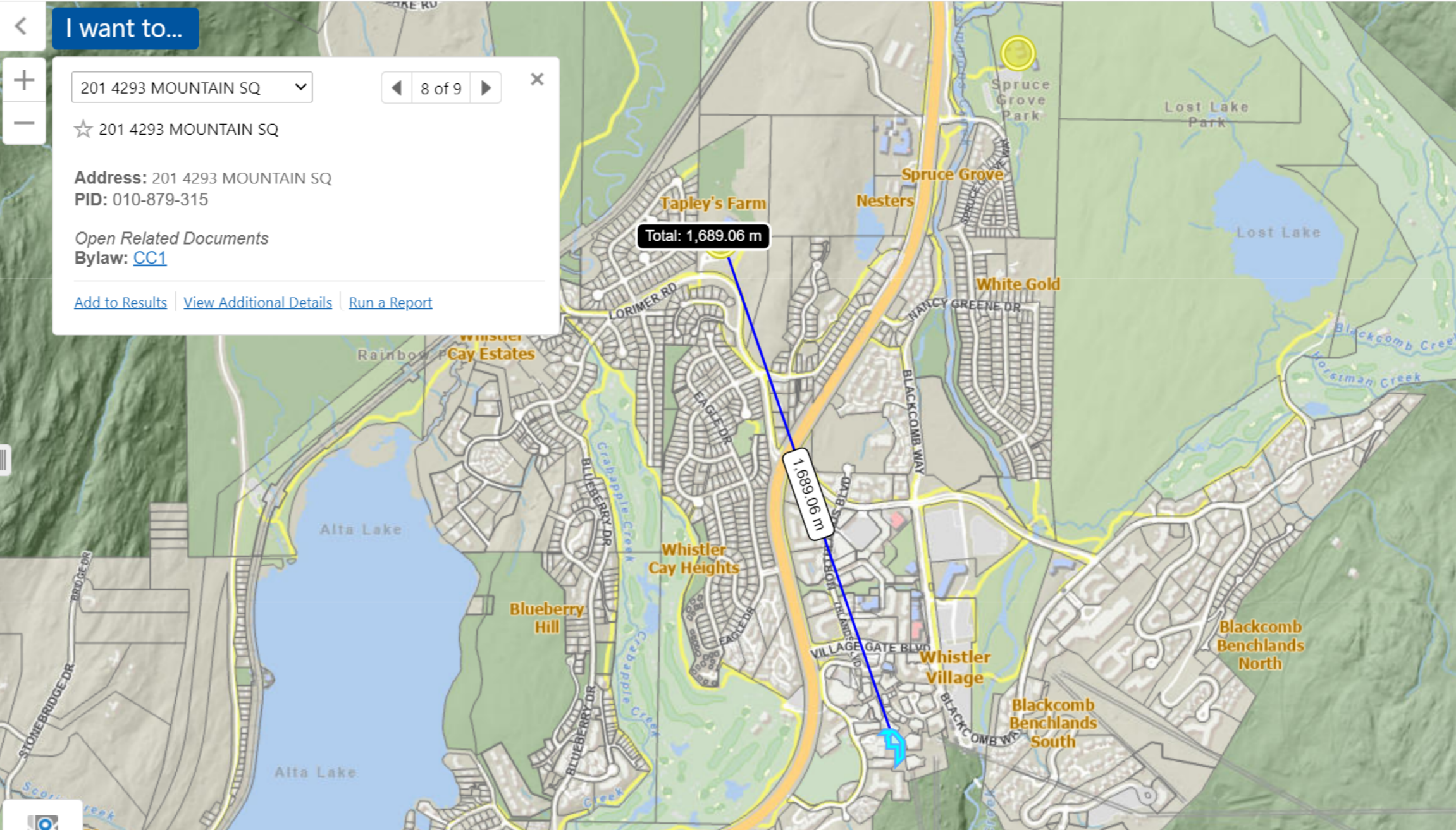

Displaying 1 - 5 (Total: 5)

Page 1 of 1

← Valley Trail

Google Street View

Jul 2016

Note: The location of our proposed store is down the access hallway, located entirely off of the village stroll to comply with the RMOV cannabis retail regulations.



Google

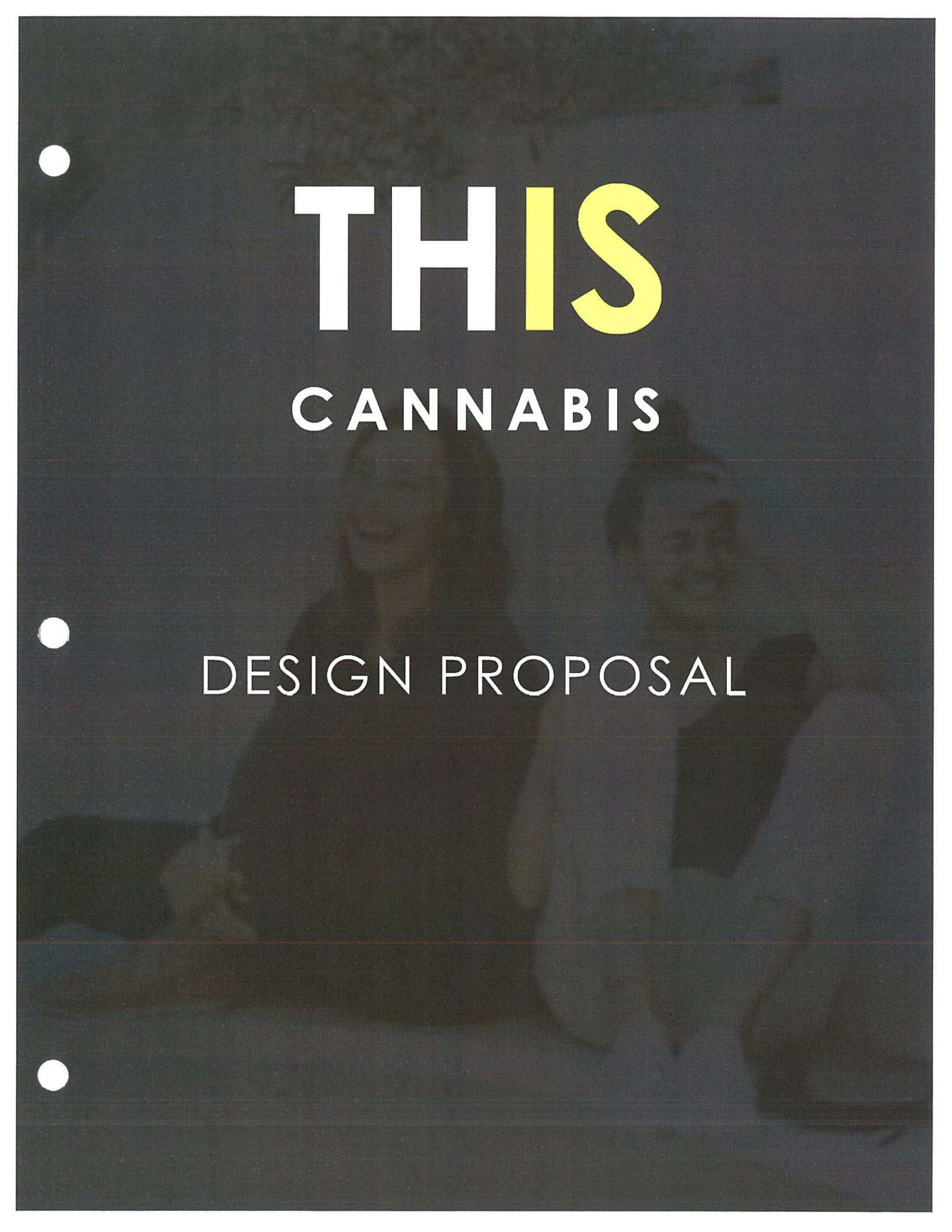

THIS

CANNABIS

DESIGN PROPOSAL

FLOOR PLAN

This is Cannabis TI
4050 Whistler Way, Whistler, B.C.
Project: PN4063
Oct 18, 2022

3 45953 Airport Rd
Chilliwack
British Columbia
V2P 1A3
1 604 792 0826



PRECISION
building design associates ltd



CODE ANALYSIS

BRITISH COLUMBIA BUILDING CODE (BCBC) - PART 3

EXISTING BUILDING INFORMATION

- 3.2.2.28 (1) & (2) BCBC - UNIT GROUP C RESIDENTIAL (A-2 ADDITION)
- SPRINKLERED
- NON-COMBUSTIBLE CONSTRUCTION
- FLOORS BY SEPARATION
- ROOF ASSEMBLY - BY FIRE RESISTANCE RATING

11.2 APPLICATION TO EXISTING BUILDINGS

11.2.2(2) WHERE A BUILDING IS ALTERED, REHABILITATED, RENOVATED, REPAIRED OR A CHANGE IN OCCUPANCY, THE LEVEL OF LIFE SAFETY AND THE BUILDING PERFORMANCE SHALL NOT DECREASE BELOW THE LEVEL THAT ALREADY EXISTS.

3.3.17 OCCUPANT LOAD

- AS PER 3.3.17.1 - OCCUPANT LOAD TABLE
- MERCANTILE SAGEMENT AND FIRST STOREY = 3.7 PER PERSON, OFFICE = 9.3 PER PERSON, STORAGE = 24 PER PERSON
- CLASIFICATION AND USE:
- $1.35 \text{ m}^2 / 3.33 \text{ sq ft} \times (205 \text{ m}^2 / 9.3) \times 3.3 + (2.5 \text{ m}^2 / 28 \text{ sq ft}) \times 1 = 9.9 \text{ PEOPLE} \approx 14 \text{ PEOPLE}$

3.2.7 LIGHTING AND EMERGENCY POWER SYSTEMS

3.2.7 EMERGENCY LIGHTING REQUIRED AND SHALL CONFORM TO ALL APPLICABLE SECTIONS OF 3.2.7

3.2.7.1(1) MINIMUM LIGHTING LEVEL IN ALL EXITS, ACCESS TO EXITS SHALL BE 50 LX AT FLOOR OR TREAD HEIGHT.

3.2.7.2(1) EMERGENCY LIGHTING OF NOT LESS THAN 10 LX AT FLOOR OR TREAD HEIGHT SHALL BE PROVIDED IN ALL EXITS, ACCESS TO EXITS, PRINCIPLE ROUTES PROVIDING ACCESS TO EXITS IN OPEN FLOOR AREAS.

3.2.7.4(1) MINIMUM BATTERY LIFE OF EMERGENCY POWER SUPPLY = 1/2 HOUR.

3.3 SAFETY MOTION FLOOR AREAS

3.3.11(1) SEPARATION OF SUITES TO BE MINIMUM OF 1 HOUR UNLESS INDICATED HIGHER BY 3.3.11(2)

3.3.11.2(1) TWO EGRESS DOORS REQUIRED FROM ROOM OR SUITE IF:

- A) INTENDED FOR OCCUPANT LOAD OVER 60
- B) TRAVEL DISTANCE OVER 20M / AREA OVER 100M² FOR GROUP B
- C) ONLY 1 EXIT REQUIRE (TRAVEL DISTANCE = 20.4 & AREA = 104.2)

3.3.11.3(1) ALL EXIT DOORS TO SWING ON A VERTICAL AXIS IN THE DIRECTION OF EXIT TRAVEL.

3.3.11.3(2) ALL EXIT AND ACCESS TO EXIT DOORS TO HAVE MINIMUM CLEAR WIDTH OF 800MM (2'-6") AND SHALL BE OPENABLE IN TRAVELING TO AN EXIT WITHOUT KEYS ETC. AND NOT OPEN ONTO A STAIR.

3.3.11.4(1) RAMPS AND STAIRS TO CONFORM TO SECTION 3.4 FOR EXIT RAMPS AND STAIRS.

3.4.1 GENERAL REQUIREMENTS

3.4.1.9 NO MIRRORS SHALL BE PLACED IN OR ADJACENT TO EXITS

3.4.2 NUMBER AND LOCATION OF EXITS

3.4.2.1(1) MINIMUM OF 3 EXITS REQUIRED FROM EACH FLOOR AREA

3.4.2.3(1) MINIMUM DISTANCE BETWEEN EXITS TO BE HALF THE MAXIMUM DIAGONAL DISTANCE OF THE FLOOR AREA

3.4.2.3(2) MAXIMUM TRAVEL DISTANCE, GROUP 4 45m

3.4.3 EXIT SIGNS

3.4.3.1(1) EXIT SIGN AND PLACEMENT SHALL CONFORM TO THIS SECTION.

3.7 HEALTH REQUIREMENTS

3.7.2.2 PLUMBING FACILITIES

CALCULATIONS BASED ON MAJOR OCCUPANCY OF F TABLE, SENTENCE 3.7.2.1

3.7.2.2(2) IF A SINGLE UNIVERSAL WASHROOM IS PROVIDED IN ACCORDANCE WITH THE REQUIREMENTS OF SECTION 3.8, THE TOTAL NUMBER OF PERSONS IN THE BUILDING USED TO DETERMINE THE NUMBER OF WATER CLOSETS TO BE PROVIDED, IS PERMITTED TO BE REDUCED BY 10

3.7.2.2(4) BOTH SEXES ARE PERMITTED TO SERVED BY A SINGLE WATER CLOSET IF THE OCCUPANT LOAD IS AN OCCUPANCY REFERRED TO IN SENTENCE (3) IS NOT MORE THAN 10.

-10 PEOPLE

-1 UNisex BATHROOM

3.8 BUILDING REQUIREMENTS FOR PERSONS WITH DISABILITIES

3.8.3.32(1) WASH-ROOM FOR PERSONS WITH DISABILITIES TO BE PROVIDED

3.8.3.32(2) ALL AREAS ACCESSIBLE TO THE PUBLIC ARE ACCESSIBLE TO PERSONS WITH DISABILITIES

3.8.3.32(3) PATHS OF TRAVEL TO HAVE AN UNINTERRUPTED WIDTH OF NOT LESS THAN 1500mm, AND A GRADIENT NOT MORE THAN 1 IN 20

3.8.3.32(4) DOORS TO BE POWER OPERATED

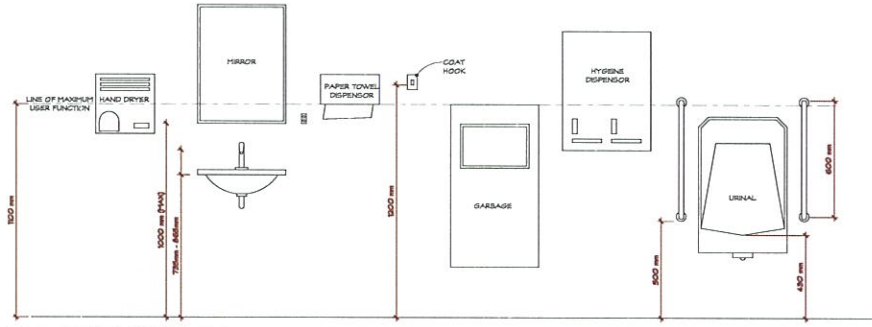

TYP. HC ELEVATION
T = T-O'

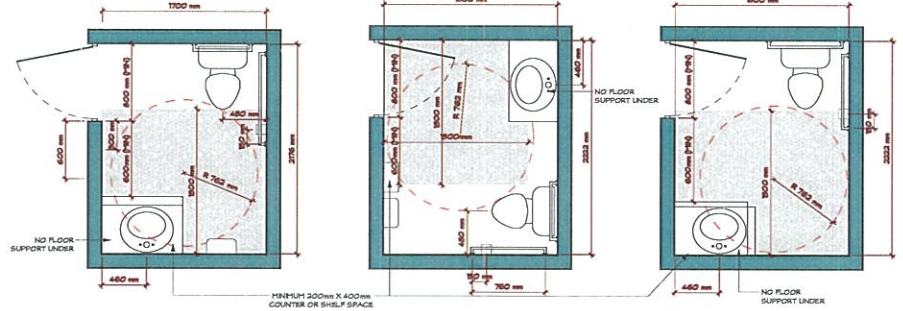

TYP. HC MIN.
1/2" = 1'-0"

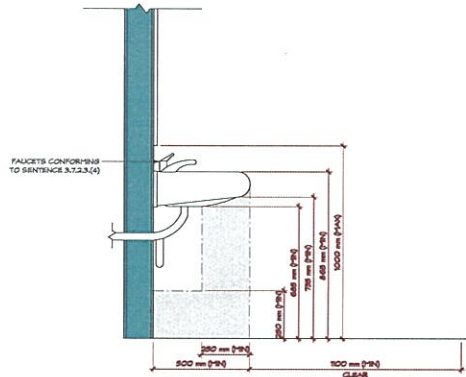

TYP. HC SINK ELEVATION
T = T-O'

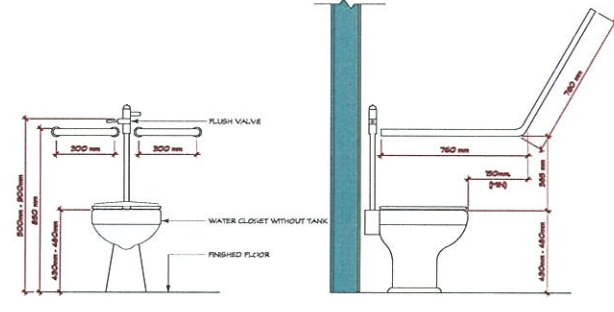

TYP. HC TOILET (NO TANK) ELEVATION
T = T-O'

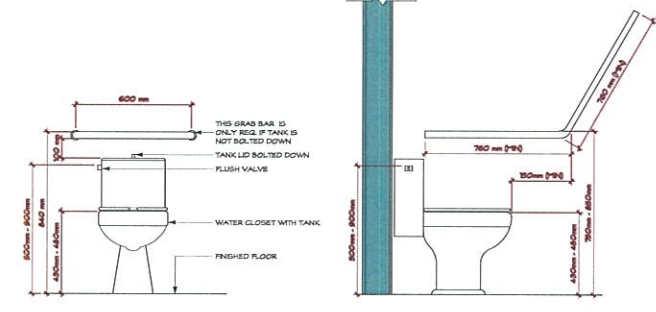

TYP. HC TOILET (TANK) ELEVATION
T = T-O'

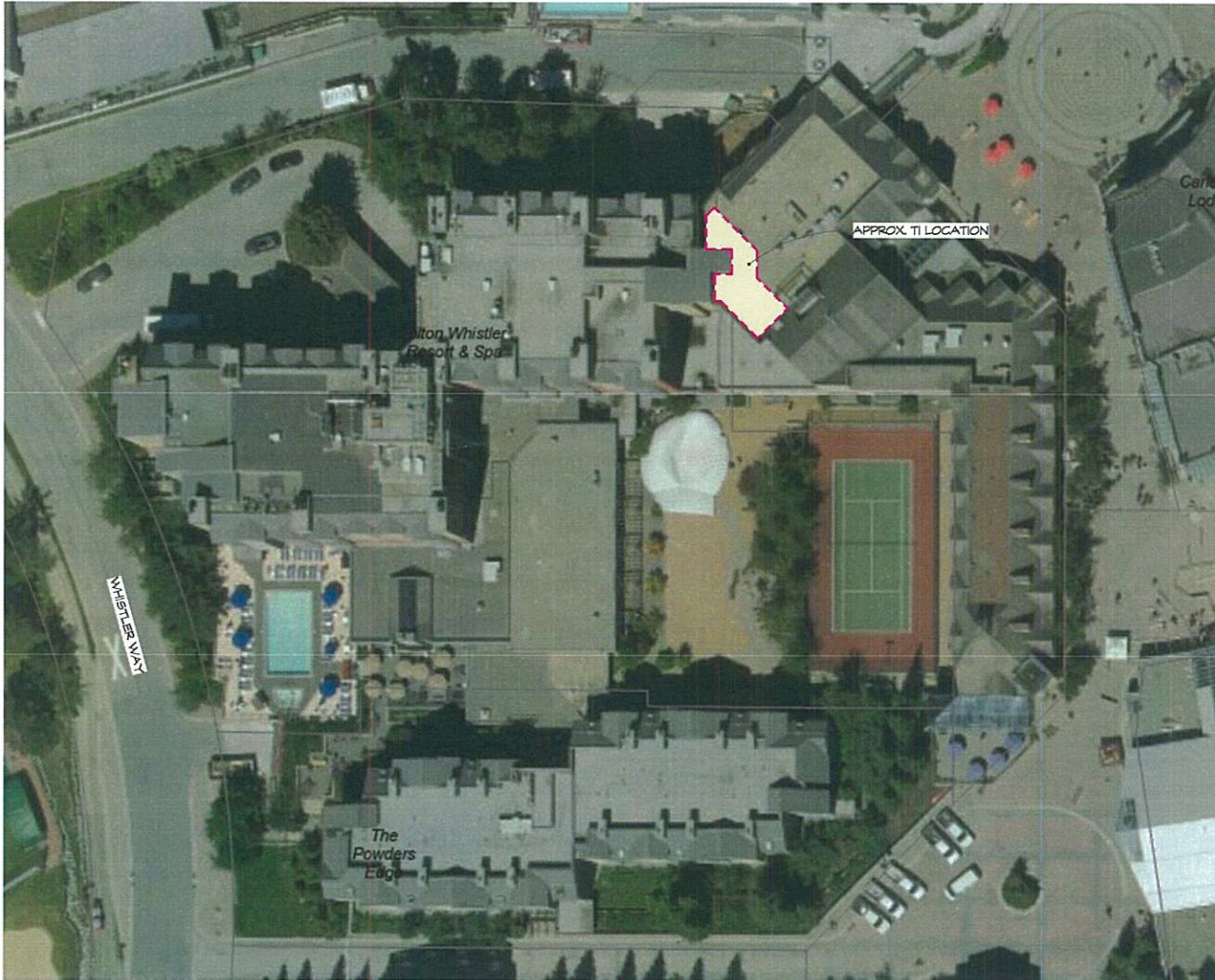

SITE PLAN
NOT TO SCALE



GENERAL NOTES

A. NOTES

1. THESE DRAWINGS AND THE IDEAS CONTAINED IN THEM ARE AND REMAIN THE EXCLUSIVE PROPERTY OF PRECISION ASSOCIATES.
2. THE BUILDER SHALL CHECK AND VERIFY ALL DRAWINGS AND DIMENSIONS FOR ACCURACY PRIOR TO THE COMMENCEMENT OF CONSTRUCTION AND SHALL REPORT ANY DISCREPANCIES TO PRECISION ASSOCIATES.
3. DRAWINGS MAY BE SCALED, BUT WRITTEN DIMENSIONS SHALL TAKE PRECEDENCE.
4. CONSTRUCTION MATERIALS AND PROCEDURES SHALL CONFORM TO THE REQUIREMENTS OUTLINED IN THE B.C. BUILDING CODE (DESCRIBED BELOW) AND ALL APPENDICES THEREOF, AS WELL AS ANY APPLICABLE LOCAL BYLAWS.
5. THE BUILDER SHALL TAKE PRECAUTIONS AS OUTLINED BY THE CANADIAN CONSTRUCTION SAFETY CODE TO ENSURE THE PUBLIC'S SAFETY DURING CONSTRUCTION.
6. THE BUILDER SHALL TAKE ADEQUATE PRECAUTIONS TO STORE MATERIALS PROPERLY ON SITE TO AVOID THEM FROM DAMAGE.
7. READ THESE DRAWINGS IN CONJUNCTION WITH STRUCTURAL, MECHANICAL, ELECTRICAL, DECORATIVE, CIVIL, AND SHOP DRAWINGS PREPARED BY OTHER CONSULTANTS.
8. THE CONTRACTOR SHALL BE RESPONSIBLE FOR OBTAINING ALL RELEVANT PERMITS, AND SHALL CALL FOR ALL NECESSARY INSPECTIONS BY AUTHORITY HAVING JURISDICTION.

B. SITE WORK

1. SLOPE ALL FINISHED GRADES AWAY FROM THE BUILDING AT A MINIMUM OF 1% TO FACILITATE RUN-OFF OF SURFACE WATER.
2. DO NOT DRAIN SURFACE WATER ONTO ADJACENT PROPERTIES.
3. GRADED SLOPES SHALL NOT EXCEED THE NATURAL ANGLE OF REPOSE FOR THE TYPE OF MATERIAL BEING USED UNLESS APPROVED COUNTERACTING MEASURES ARE UNDERTAKEN.

C. FOUNDATIONS

1. FOOTINGS SHALL REST ON SUITABLE BEARINGS PER STRUCTURAL/CIVIL/GEOTECH.
2. ALLOW OPENINGS IN FOUNDATIONS FOR SERVICES AS REQUIRED, CONFORM BEFORE POURING CONCRETE.
3. DO NOT JACKLIFT BEFORE FLOOR JOISTS AND SUBFLOORS ARE SECURELY IN PLACE, NOR BEFORE CONCRETE HAS REACHED ITS 28 DAY STRENGTH.
4. PROTECT WOOD MEMBERS IN CONTACT WITH CONCRETE WITH A 3/8" DASH PROFORM COURSE OR A LAYER OF 6# POLY.
5. FOUNDATION WALL AND FOOTING CONCRETE PER STRUCTURAL DRAWINGS.

D. FRAMING

1. FRAMING LUMBER SHALL BE #2 OR BETTER, DOUGLAS FIR UNLESS NOTED OTHERWISE.
2. FRAMING METHODS AND PROCEDURES SHALL REFER TO STRUCTURAL DRAWINGS.
3. ALL EXPOSED LUMBER SHALL BE PRESSURE TREATED OR OTHERWISE PROTECTED WITH AN APPROVED PRESERVATIVE COMPOUND, TOUCH UP ALL SCAFFOLD, SPIGOTS, ETC.
4. START CONSTRUCTION SHALL CONFORM TO THE REQUIREMENTS OF THE B.C. BUILDING CODE.

PRECISION building design associates ltd.
 34363 Airport Rd
 Chilliwack
 British Columbia
 V2P 1A3
 1.604.792.0126

Project: P14063
 Scale: AS SHOWN
 Geoplot/checked by: CHLDRBANDT
 Date: 04/18/2022
 Sheet: A1.0

This is Cannabis TI
 4050 Whistler Way, Whistler, B.C.

Drawing Title: Construction Permit Drawings
 Siteplan & Zoning

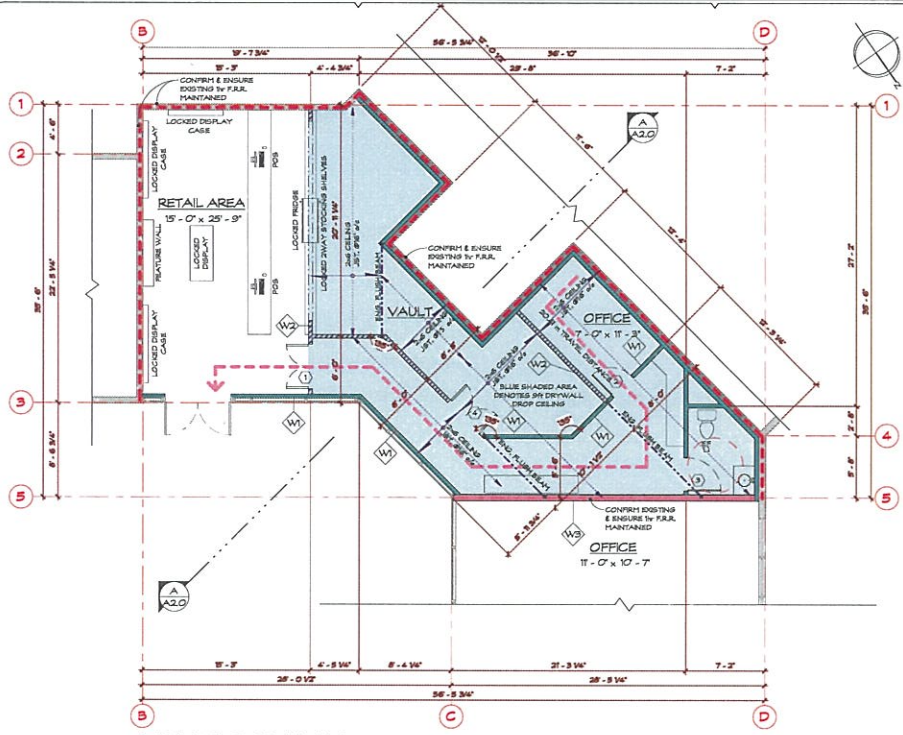

MAIN FLOOR PLAN
 3/16" = 1'-0"
 APPROX. 122 SQ. FT. FLOOR AREA

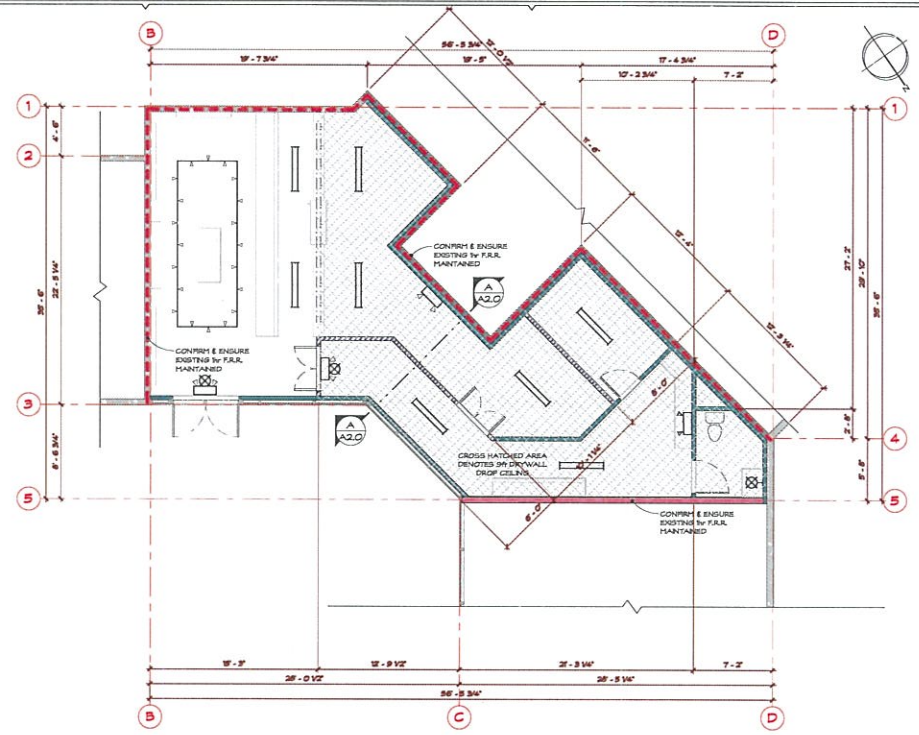

REFLECTED CEILING PLAN
 3/16" = 1'-0"
 EXISTING SUPPLY AND RETURN DIFFUSERS/GILLES TO BE MAINTAINED & UTILIZED BY NEW OCCUPANCY

| DOOR SCHEDULE | | | | | | |
|---------------|----------|--------|--------|-------|----------|-------------------------------------|
| SYMBOL | LOCATION | WIDTH | HEIGHT | TOTAL | MATERIAL | NOTES |
| 1 | INTERIOR | 4'-0" | 6'-8" | 1 | STEEL | DOUBLE DOOR, HANDLE, LOCKABLE |
| 2 | INTERIOR | 2'-0" | 6'-8" | 1 | WOOD | HANDLED DOOR, CLOSURE, LOCKABLE |
| 3 | INTERIOR | 3'-0" | 6'-8" | 1 | WOOD | PRIVATE SET ON BATHROOMS |
| 4 | INTERIOR | 4'-0" | 6'-8" | 1 | STEEL | VAULT DOUBLE DOOR, HANDLE, LOCKABLE |
| 7 | | 18'-0" | 7'-0" | 1 | | OPENING |

| LEGEND | |
|--------|------------------------------|
| | CONCRETE WALLS |
| | 2x4/2x6 WOOD WALLS |
| | 2x4/2x6 BEARING WALLS |
| | EXISTING WALLS TO REMAIN |
| | EXISTING WALLS TO BE REMOVED |
| | EXISTING 1 W/ F.R.R. |
| | SH DRYWALL CEILING |

ALL EXISTING STRUCTURE, DIMENSIONS, MATERIALS, FINISHES, ROOF RITCH, OVERHANGS, HELL HEIGHTS TO BE CONFIRMED ON SITE PRIOR TO GRADING MATERIALS, OR COMMENSURE DEMOLITION AND CONSTRUCTION

- ALL HEADERS IN EXTERIOR/INTERIOR BEARING WALLS TO BE 2x10, 3x10 OVER OPENINGS GREATER THAN 5'-0" WIDE UNLESS NOTED OTHERWISE
- OPENINGS ARE TAKEN FROM OUTER FACE OF PL-WOOD SHEATHING OR CONCRETE FOUNDATION TO CENTERLINE OF INTERIOR PARTITIONS OR EDGE OF FLOOR BELOW AND/OR ABOVE
- ALL DOORS LOCATED AT CENTER OF WALL OR WITH 4" TRIMMED JAMBS UNLESS NOTED OTHERWISE
- ALL F.R.R. FRAMES TO BE SUPPORTED BY A F.R.R. STRUCTURE

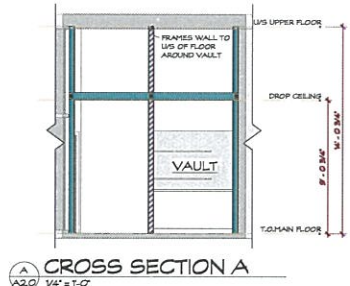

CROSS SECTION A
 1/4" = 1'-0"

| ELEC. LEGEND | |
|--------------|--------------------------------|
| | EMERGENCY LIGHTING W/EXIT SIGN |
| | 4ft STRIP (SURFACE/SUSPENDED) |
| | TRACK LIGHTING |





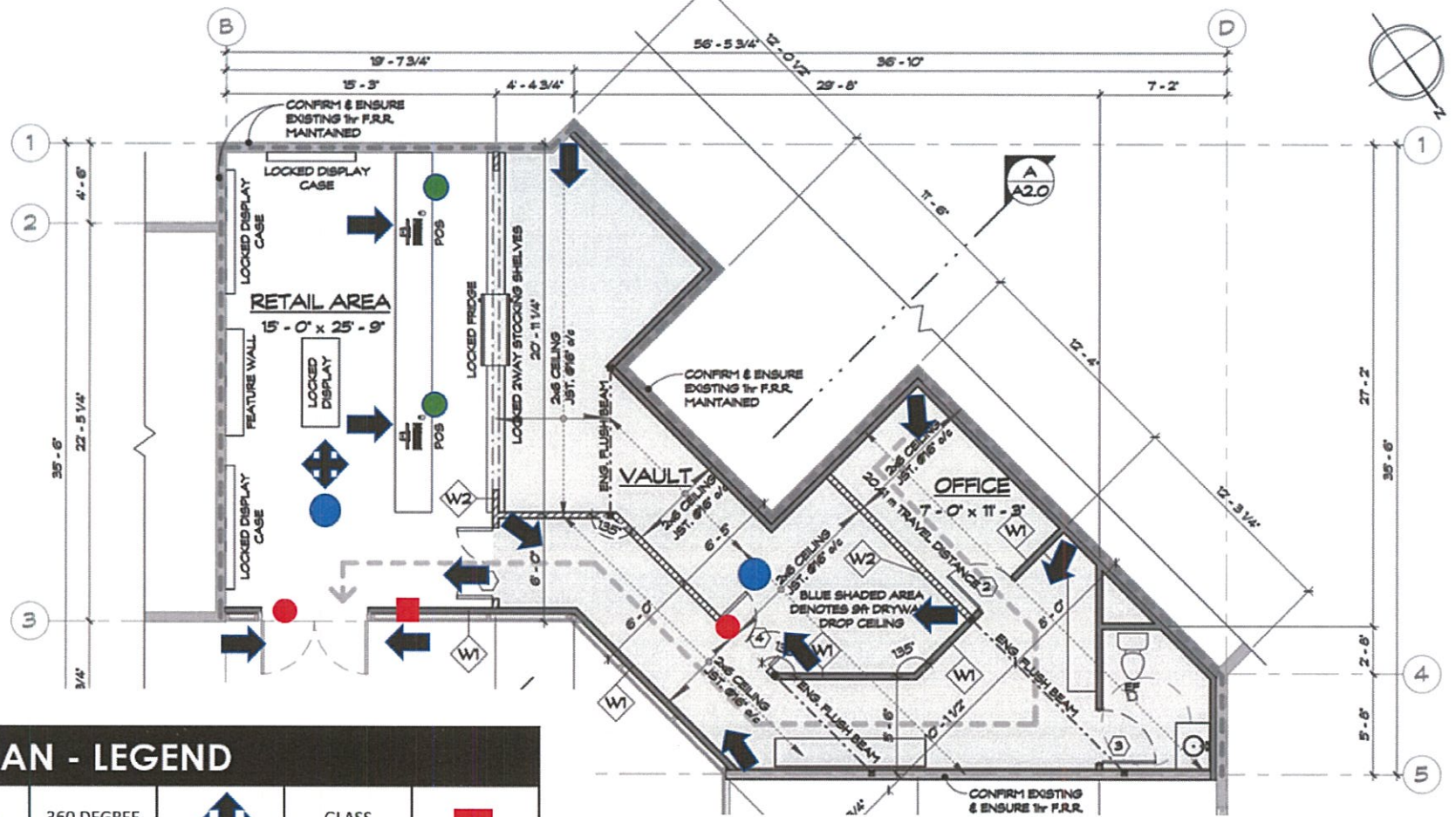

| ASSEMBLIES | |
|------------|---|
| W1 | INTERIOR WALLS 2x4 (OR 2x6) STUDS @ 16" W/6 WITH DEL TOP AND SINGLE BOTTOM PLATES 1/2" GWS FINISHED |
| W2 | INTERIOR BEARING WALLS (DATCHED) 2x4 (OR 2x6) STUDS @ 16" W/6 DEL TOP AND SINGLE BOTTOM PLATES 1/2" GWS FINISHED |
| W3 | INTERIOR WALLS (1R F.R.R. AS 51C AG PER BCBC 2018, TABLE A-8.10.3.1.A, ASSEMBLY W3) R-2 BATT INSULATION R-5 BATT INSULATION 1/2" TYPE X GWS FINISHED EACH SIDE |

ALL ASSEMBLIES TO BE CONFIRMED BY STRUCTURAL ENGINEER

SECURITY PLAN



SECURITY PLAN - LEGEND

| | | | | | |
|-------------------|---|-------------------|---|--------------|---|
| STATIONARY CAMERA |  | 360 DEGREE CAMERA |  | GLASS BREAK |  |
| 360 DEGREE MOTION |  | DOOR CONTACTS |  | PANIC BUTTON |  |

SITE PLAN

MACDONALD COMMERCIAL
REAL ESTATE SERVICES LTD.
1827 W 5th Ave
Vancouver, BC V6J 1P5
Tel (604) 736-5611
Fax (604) 736-7976
www.macdonaldcommercial.com

201A and 201B – 4293 Mountain Square Whistler, BC

4293 MOUNTAIN SQUARE
WHISTLER, BC

PLAZA FLOOR PLAN

Measured: June 22, 2017
Updated: Sep 25, 2017



YT Technologies
Toll Free: (855) 999-8832
File #: 17-01-639
www.yttechnologies.com

STORE VENTILATION

Odour control and store ventilation was an important part of our store design in the first two stores we opened in Chilliwack and Abbotsford. These stores are both in busy commercial strip malls with neighbours on both sides of our stores. In three years of operations we haven't had a single complaint about odours coming from our store. We always consult mechanical engineers in the renovation process to ensure the HVAC systems are adequate and install HEPA air filtration systems to mitigate odours.

This will be no different in the design and construction of our store in Whistler. As per 5.4(r) of our Lease agreement, we have committed to the following:

- 1. The Tenant covenants with the Landlord that no noxious nor strong odours (Cannabis or otherwise) will permeate from the Leased Premises or from the Tenant's activities into other premises or the Common Areas and Common Facilities.*
- 2. The Tenant, at its own cost and expense, will supply and install in the Leased Premises sufficient professional-grade exhaust systems, carbon filter systems, and other installations as recommended in a report (the "HVAC Report") from the Landlord's HVAC consultant (the "HVAC Consultant"), which may include but are not limited to fans, ecologizers, makeup air equipment, and exhaust ducts and louvers that will expediently remove and prevent the spread of any noxious or strong odours from the Leased Premises.*
- 3. The Tenant covenants to abide at its own cost and expense, any requirements and recommendations stated in the HVAC Report and any further recommendations made by the HVAC Consultant or the Landlord, from time to time, with respect to containing and preventing the spread of any noxious or strong odours, failing which the Landlord will have the right to do so on the Tenant's behalf and charge the Tenant for the cost thereof, plus a fifteen (15%) percent administration fee thereon.*

ODOUR CONTROL PLAN

The 3-stage filtration process of a HEPA system is used to create a very effective filtration system. Each filter is independent and can be changed individually.

Stage 1. Pre-filter - The inexpensive foam pre-filter removes larger particulates from the air, thus prolonging the life of the HEPA filter.

Stage 2. HEPA - The HEPA filter removes 99.97% of particulates 0.3 micron and larger. The cleaned air then passes through the third stage filter.

Stage 3. Carbon - The carbon filter is about 1/2 an inch thick to give it plenty of surface area for removing chemicals and odors from the air. This filter may be replaced by an optional heavy duty granular carbon canister available for maximum removal of chemicals and odors. The clean air is then reintroduced into the air you breathe.

Under normal conditions the HEPA filter will last from two to five years however regular service and maintenance of these filters is important to ensure efficient operation. All installation and maintenance should and will be performed by a professional contractor. The installer will be made aware of our indoor air quality and be familiar with our heating, ventilation and air conditioning equipment.

Brochures and specifications on the HEPA air filtration system can be seen in the following documents.

Breathing isn't an option.
But your air quality is.

Choose wisely,
Choose **Amaircare**®.

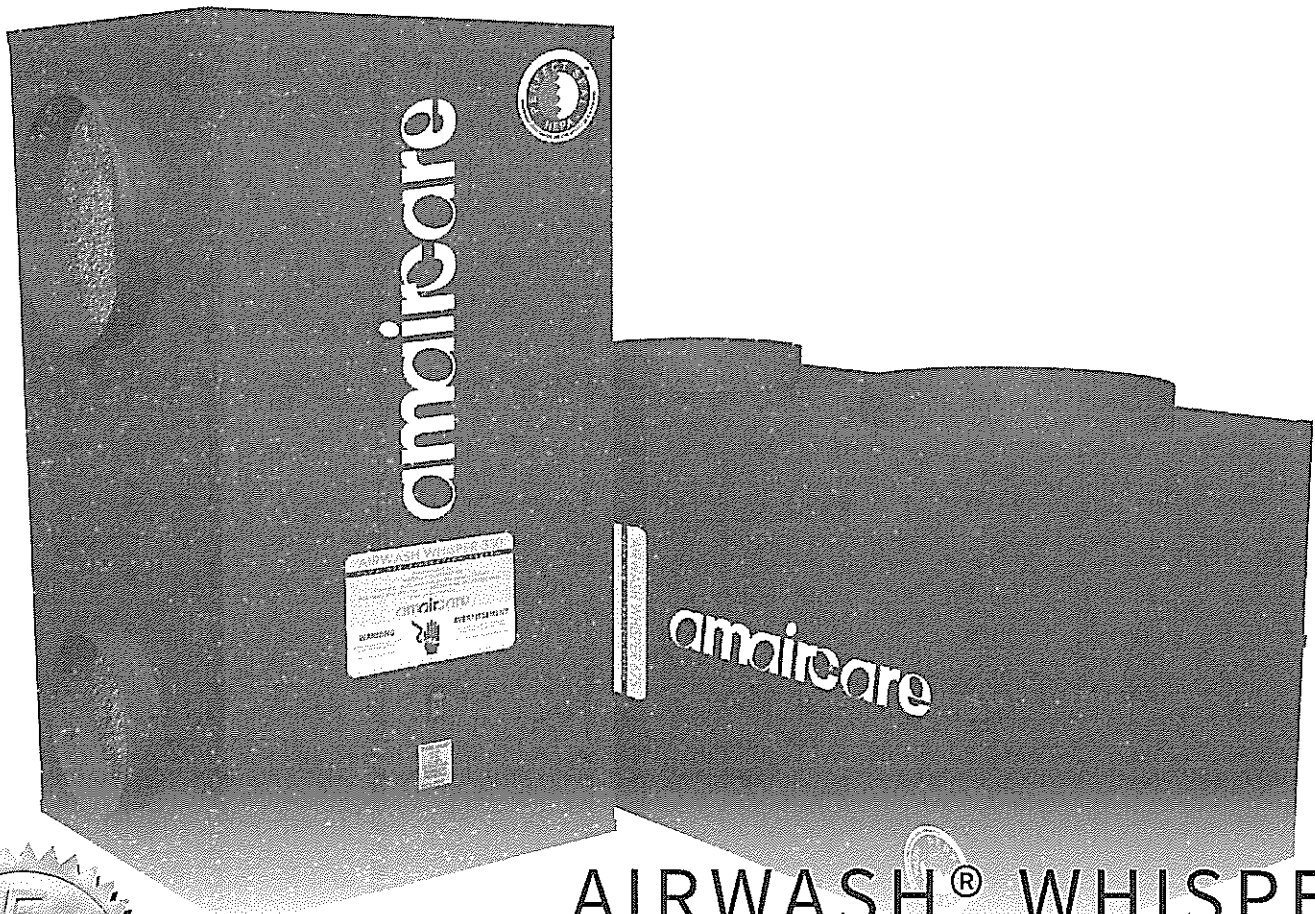

AIRWASH® WHISPER
HEPA AIR FILTRATION SYSTEMS

amaircare
Cleaning the air you breathe.

Models:
AWW350 and AWW675

The focus of Amaircare products is to bring you the cleanest, safest air for breathing.
Indoor air is often up to 5 times more polluted than outside air. We can help you change that!

UNDERSTANDING AIR POLLUTION

Air pollution can be divided into 3 categories:

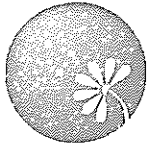

PARTICULATES

Air pollutants that have mass, such as: vehicle emissions, pollen, dust mite carcasses & feces, pet dander, cigarette smoke & candle soot.

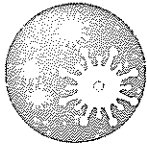

BIOBURDEN

Biological material, living or dead, in the air, such as: bacteria & viruses, mold spores, fungi. These materials cause allergies and spread diseases.



V.O.C.'s (VOLATILE ORGANIC COMPOUNDS)

Gas state of chemicals. In your home they come from household materials and cleaning products. V.O.C.'s include chemicals released from: paints, perfumes, plastic, cigarette smoke, furniture & carpets, glue to name a few.



PERFECT SEAL HEPA™

Many other products falsely claim to meet HEPA standards. Amaircare provides true HEPA results. Our products can filter out 99.97% of particles 0.3 micron because our filters are sealed properly. Our unique construction forces all air to pass through the filter material!

FIX THE PROBLEM



Amaircare HEPA Air Filtration Products employ simple proven technology to solve the 3 categories of air pollution safely and without adding new pollutants.

What is HEPA?

HIGH EFFICIENCY PARTICULATE ARRESTANCE is a filtration standard created by the US Atomic Energy Commission. To qualify as a HEPA filter, a media must be 99.97% efficient at removing particles 0.3 micron in size. Approximately, 85% of easily measureable particulate pollution in the air is 0.3 micron in size.

A micron is 300 times smaller than the thickness of one human hair.

Amaircare products include certified HEPA filter media as part of a 3-stage filtration process.

-  1st stage: PREFILTER filters large particulate and captures some V.O.C.s
-  2nd stage: HEPA FILTER filters bioburden, particulate and attached V.O.C.s
-  3rd stage: INNER CARBON FILTER – captures residual V.O.C.'s

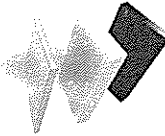

BENEFITS OF AMAIRCARE AIRWASH WHISPER HEPA AIR FILTRATION SYSTEMS

- Insulated cabinets for whisper quiet operation.
- Low maintenance, our HEPA cartridges can last up to five years or longer.
- Amaircare products produce NO Ozone.
- Our products are energy efficient due to effective design and quality motors.
- Amaircare Air Filtration systems are constructed out of durable steel.
- Our products are environmentally friendly
- Upgrade VOC Canister available for increased chemical adsorption capacity

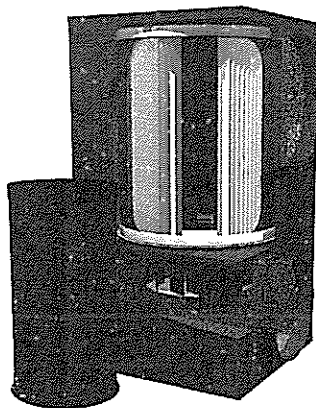

SPECIFICATIONS: (all models)

Color: Meteorite
Dimensions: 14.5"W x 27.5"H
Motor/Fan: Designed for continuous operation
Run tested for 50,000+ hours

Airwash Whisper 350

Intake: 8" Duct Collar
Outake: 6" Duct Collar
Weight: 30 lbs.
Air Flow: 350 C.F.M
Power Usage: 125 Watts

Airwash Whisper 675

Intake: 10" Duct Collar
Outake: 8" Duct Collar
Weight: 33 lbs.
Air Flow: 675 C.F.M
Power Usage: 225 Watts

AMAIRCARE PORTABLE AIR FILTRATION SYSTEMS:

Amaircare also manufactures a whole line of portable air filtration products. Units range from as small as an auto filter for use in the car to systems that can clean the air in several large rooms at once.



Amaircare Products available at:

visit
www.amaircare.com
for more details

amaircare
Cleaning the air you breathe.

Americair Corporation 770 Gana Crt. Mississauga, ON Canada

AMAIRCARE AIRWASH WHISPER 675
110V Whole Home Air Filtration System
PART NUMBER: 14-A-1KME-00

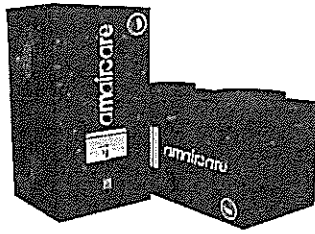

Machine comes with the following parts:

1. Stage 1 – Foam Pre-filter
 2. Stage 2 – HEPA Filter
 3. Stage 3 – Carbon Inner Filter
- OPTIONAL Stage – VOC Canister (available on request)**

Amaircare AirWash Whisper 675 Whole Home air filtration system can effectively clean the air in an entire Home or Office.

Classification: Whole Home HEPA (High Efficiency Particulate Arrestance) 100% Sealed Air Cleaning Device

Dimensions: 14.375"W x 14.375"L x 27"H

Weight: 36lbs. with HEPA configuration

Airflow: 675 CFM

Power Usage: 225 W

HEPA Material: HEPA Cartridge Efficiency: 99.97% minimum at 0.3 micron particle and above

Materials: 24 gauge steel housing

Finish: Baked Thermoset Powder Finish

Service Area: 5050 sq. ft. for 1 air change per hour

DBA Rating @ 6': 65 db

Control: Toggle On/Off

Intake: 10" D

Outflow: 8" D



Cleaning the air you breathe.

AIR CLEANERS/
FILTERS

AIRWASH WHISPER

HEPA BYPASS AIR FILTRATION SYSTEM

HOMEOWNERS MANUAL & DEALER INSTALLATION INSTRUCTIONS
FOR AirWash WHISPER MODELS 350 & 675

Rules for Safe Installation and Operation

READ AND SAVE
THESE INSTRUCTIONS!

Please read instructions before installing and using the HEPA Bypass Air Filtration System (HEPA system). This will help you obtain the full benefit of the HEPA system you have selected. It will also help you to avoid needless service costs.

- 1. Read this manual carefully. Failure to follow these rules and instructions could cause a malfunction of the air filter or unsatisfactory service and could void your warranty.
- 2. Follow a regular service and maintenance schedule to ensure efficient operation.
- 3. For safety and optimized performance of your HEPA system, all installation and maintenance must be performed by a professional heating and ventilation contractor. The installer should be made aware of your indoor air quality situation and be familiar with your heating, ventilation and air conditioning equipment.
- 4. High particulate distribution may occur during initial start-up of this product after installation or after scheduled filter changes. Individuals who are highly sensitive to airborne particulates should not be in the building and allow 24 hours of operation for removal of particulates from occupied spaces before re-entry.

Shipping and Packing List

Package 1 of 1 contains:

- 1 - HEPA System
- 1 - Complete Filter Set (Packed inside Unit)
- 1 - Installation Instructions (this manual)
- 1 - Registration Card

HEPA System Models

Model AirWash Whisper-350 (AWW-350) is designed to filter air up to a rate of 350 cfm.

Model AirWash Whisper-675 (AWW-675) is designed to filter air up to a rate of 675 cfm.

WARNING

Risk of property damage, injury or death.

Installation, adjustments, alterations, service and maintenance must be performed by a qualified technician.

WARNING

Risk of Carbon Monoxide Poisoning.

Can cause injury or death.

Do not operate equipment without access panel in place. Operation of this equipment without all access panels in place may cause gas fumes from the heating system to be drawn into occupied spaces.

WARNING

Electrical Shock Hazard.

Can cause injury or death.

Disconnect all electrical power supplies before servicing.

Do not operate equipment without access panels in place.



Table of Contents

| | |
|--|--|
| Rules for Safe Installation and Operation .. 1 | Filter Change Schedule.....9 |
| Shipping and Packing List..... 1 | Filter Changing Guidelines.....9 |
| Specifications2 | Dealer Filter Change Instructions.....10 |
| Introduction.....2 | Dealer Motor Assembly |
| General Information.....3 | Replacement Instructions.....11 |
| Product Application Guidelines3 | Electrical Diagram.....11 |
| Parts Identification.....4 | Replacement Parts.....12 |
| Physical Dimensions of Units.....5 | |
| Dealer Installation Instructions 6-8 | |
| Operation.....9 | |
| Maintenance.....9 | |

Specifications

| | AWW-350 | AWW-675 |
|---|-----------|-----------|
| Nom. Air Flow @ 120VAC @ 0.0" E.S.P. | 350 cfm | 675 cfm |
| Weight (max - unpackaged) | 30 lbs. | 33 lbs. |
| Supply Voltage | 120 VAC | 120 VAC |
| Nom. Measured Power Consumption | 125 Watts | 225 Watts |
| Motor Current Draw - Total | 1.0 amps | 1.8 amps |
| Air Intake Collar (max) | 8"-round | 10"-round |
| Air Outflow Collar (max) | 6"-round | 8"-round |
| Operating Temp. Range - Return air (°F) | 30 to 95 | 30 to 95 |

HEPA filter efficiency = 99.97% @ 0.3 micron particles
 Ambient temperature range: -40°F to 130°F

Introduction

Congratulations! You will quickly realize that you have purchased a very effective air cleaning system. It incorporates state of the art HEPA (High Efficiency Particulate Air) technology.

Your Amaircare® HEPA system comes with a limited warranty. With proper attention to its care and maintenance, you will receive optimum performance.

If your indoor air has abnormally high concentrations of particulates, the life span of the filter media may be shortened. Excessive particulates in the air will reduce the expected life of the HEPA filter. Under normal conditions the HEPA filter will last from two to five years.

The optional activated carbon canister has a finite limit as to the amount of odor or other gaseous volatile organic compounds (V.O.C.'s) that it can adsorb. The higher the concentrations, the shorter the expected life. Higher humidity may shorten the life of the carbon canister. Under normal conditions, the carbon canister should

last up to 12 months.

Initially, the HEPA filter's particulate removal efficiency improves with use. However, the air flow through the HEPA filter media will decrease, as dust builds up on the filter, thus lowering its ability to circulate and clean as much air as when it was new. If the air flow through your unit is noticeably reduced, you can inspect the pre-filter and HEPA filter to see if they should be replaced. Replacement (or washing if foam) of the pre-filter every 3 months will help extend the life of the HEPA filter.

Please contact your local Amaircare® dealer regarding replacement of filter media, warranty information or if you have any questions or concerns about the performance of your HEPA system.

NOTE: This filtration system is an ADDITIONAL filter, and does NOT replace the existing air handler/furnace system filter.

General Information

Media Filters

Media filters strain particulates from the air. The filter media needs to have tiny holes to allow air to pass through, but not particulates. Filter types vary for all sorts of purposes. The most effective and proven filter media is HEPA. HEPA filter media is 99.97% efficient at capturing particles which are 0.3 micron in size or larger.

Carbon Filters

Carbon media is used to capture chemicals and odors, also referred to as V.O.C.'s. Chemicals and odors cannot be captured with media type filters. Activated carbon collects chemicals and odors in a process called adsorption. If air passes through the carbon filter before particulates are removed, the surface of the carbon quickly gets covered with particulates, rendering it ineffective at capturing chemicals and odors. If particulates are removed from the air with a HEPA filter, virtually the entire surface area of the carbon can be used to capture chemicals and odors. This increases the efficiency and filter life of the carbon filter.

Separate HEPA and Carbon Filters

HEPA and carbon filters have different life spans. It is important for a filtration system to keep the filter components independent from each other, so that

the filter that is dirty/saturated can be changed. This is more economical than a system where you need to throw out two or three filters when only one needs changing.

The HEPA System's 3 Stage Filtration Process

The 3 stage filtration process is used to create a very effective filtration system. Each filter is independent and can be changed individually.

- **Stage 1: Pre-filter** - The inexpensive foam pre-filter removes larger particulates from the air, thus prolonging the life of the HEPA filter.
- **Stage 2: HEPA** - The HEPA filter removes 99.97% of particulates 0.3 micron and larger. The cleaned air then passes through the third stage filter.
- **Stage 3: Carbon** - The carbon filter is about 1/2 an inch thick to give it plenty of surface area for removing chemicals and odors from the air. This filter may be replaced by an optional heavy duty granular carbon canister available for maximum removal of chemicals and odors. The clean air is then reintroduced into the air you breathe.

Product Application Guidelines

Size of House vs. Air Changes per Hour

| Model Unit | Size of House* | | | | | | | |
|---------------|--------------------------|--------------------------|---------------------------|---------------------------|---------------------------|---------------------------|---------------------------|---------------------------|
| | 1,000 ft2 (8,000 ft3) | 1,200 ft2 (9,600 ft3) | 1,500 ft2 (12,000 ft3) | 1,800 ft2 (14,400 ft3) | 2,000 ft2 (16,000 ft3) | 2,500 ft2 (20,000 ft3) | 3,000 ft2 (24,000 ft3) | 3,500 ft2 (28,000 ft3) |
| Model AWW-350 | 2.4 | 2.0 | 1.6 | 1.4 | 1.2 | 1.0 | 0.8 | 0.7 |
| Model AWW-675 | 5.0 | 4.2 | 3.4 | 2.8 | 2.5 | 2.0 | 1.7 | 1.5 |

* Chart based on homes with 8 ft. ceilings.

Notes:

- Industry experience indicates that one (1) air change per hour generally provides adequate air cleaning. Actual results will depend on multiple factors such as outdoor particulate levels, infiltration rate, indoor activities etc.
- Generally speaking, the more air changes per hour provided, the more effective a HEPA system will be. People with sensitivities may desire a higher number of air changes per hour for cleaner air.

Parts Identification

Cabinet Parts

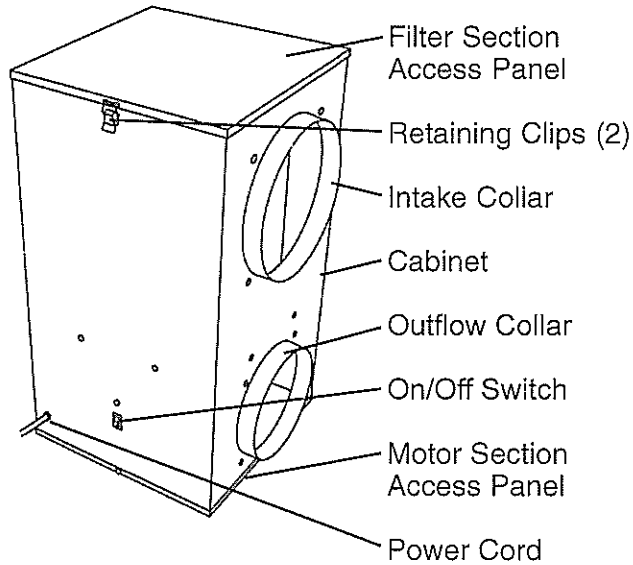

figure 1.

Inside Cabinet (Filter Section)

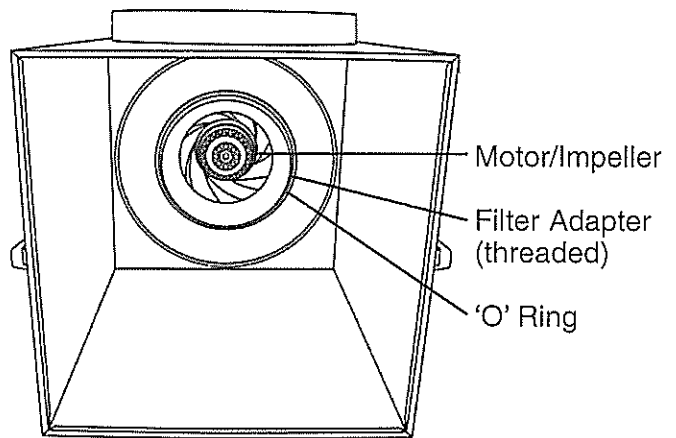

figure 2.

Filter Parts Identification

HEPA Cartridge Parts

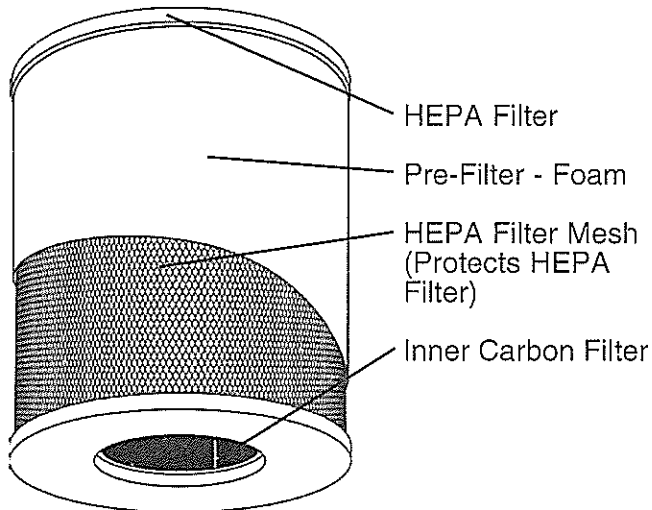

figure 7.

Optional Carbon Canister

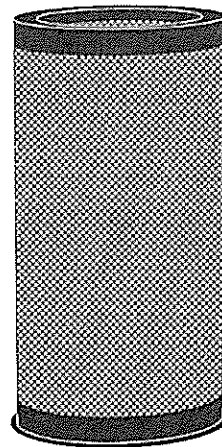

figure 8.

For third stage increased removal of chemicals and odors.

Located inside the HEPA filter.

Discard inner carbon filter when using the optional carbon canister.

Physical Dimensions of Unit

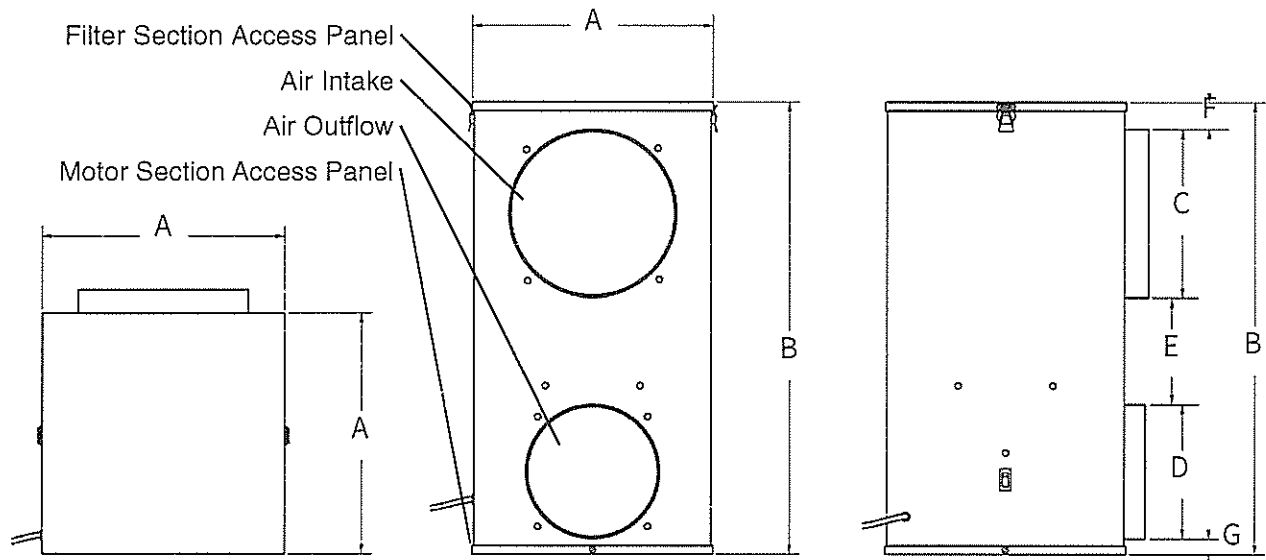

figure 11.

| MODEL NO. | A | B | C | D | E | F | G |
|---------------|---------------|----------------|----------------|----------------|--------------|-----------|-----------|
| Model AWW-350 | 14.5 (368) | 27.25 (692) | 7.875 (200) | 5.875 (149) | 8.5 (216) | 3 (76) | 2 (51) |
| Model AWW-675 | 14.5 (368) | 27.25 (692) | 9.875 (251) | 7.875 (200) | 6.5 (165) | 2 (51) | 1 (32) |

Dimensions in inches (mm)

Dealer Installation Instructions

Forced air handler/furnace systems:

The HEPA system should be installed as a bypass system, with part of the return ducted into the HEPA system. The filtered air is then rerouted back into the return air, and continues through the system to be heated/cooled.

Typical Return to Return Application

For homes with upflow forced air handler/furnace systems. (Air handler/furnace is shown in a typical basement. See figure 6.)

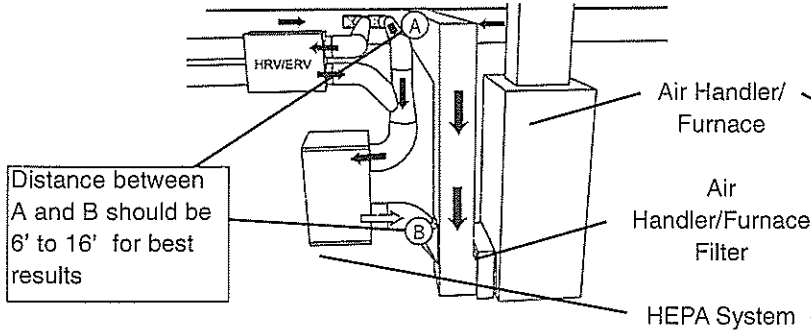

Figure 14.

Typical Return to Return Application

For homes with horizontal forced air handler/furnace systems. (Air handler/furnace is shown in a typical attic. See figure 7.)

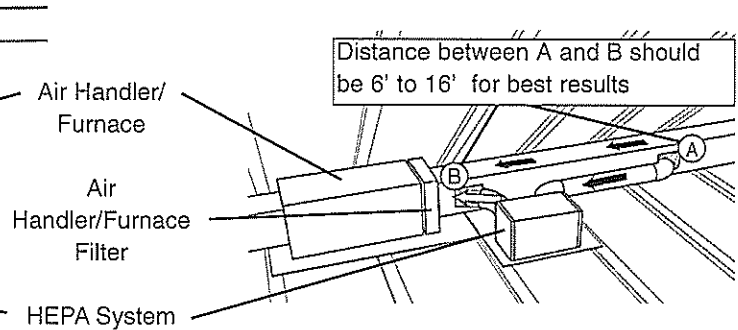

Figure 15.

NOTE: This filtration system is an **ADDITIONAL** filter, and does **NOT** replace the existing air handler/furnace system filter.

Preparation:

Here are some things to consider as you decide where to install the HEPA system.

Location:

- Make sure there is room to open the HEPA filter access panel for filter changes/inspections.
- Keep the HEPA system in a location where you can still access the air handler/furnace filter.
- Keep the HEPA system away from possible water damage.
- Vibration pads will reduce vibration for installations where the unit is placed on the floor.
- Install HEPA System on floor or suspended platform. If the unit is suspended, screws must not penetrate through the cabinet. Make sure that you have the proper chains/straps/joists and equipment to keep unit secure.

Intake (Marked as 'Air In' on unit):

- Intake ducts should be installed upstream of any humidifiers and be installed on the main return.
- Intake duct should be installed at least 6 ft. away from the outflow duct on the main return.

Outflow (Marked as 'Clean Air Out' on unit):

- Outflow duct should be installed as close to the air handler/furnace inlet as possible but not directly into the return air elbow of the main return.
- If the unit is being installed independently of any other system, room diffusers are recommended to help distribute airflow evenly in the occupied space.

Ducting:

- If HEPA system is installed where inlet and outflow collars face down, metal elbows must be connected to both inlet

and outflow collars.

- Each connection must be sealed with aluminum tape or mastic, including all take offs.
- Installed duct runs should be as straight as possible (if the duct runs are too long, reduced CFM may result).
- If duct is exposed to unconditioned air, externally insulated flex duct is highly recommended.
- Externally insulated flex duct can also be used for noise reduction purposes.
- For best indoor air quality, do not use ductboard or fiberglass inside of ducts.

Electricity:

- The unit must be plugged into a grounded 120V, 60Hz outlet.

Required Materials for Installation of Unit:

Items for AWW-350

Flex or rigid duct 8" round & 6" round
(length as required)

Takeoffs One 8" & One 6"

Items for AWW-675

Flex or rigid duct 10" round & 8" round
(length as required)

Takeoffs One 10" & One 8"

All Models

Aluminum tape or mastic as required

Misc. hanging materials - field provided

NOTE: Be sure to review 'Rules for Safe Installation and Operation' on page 1 of this document before start-up of this unit.

Dealer Installation Instructions

Forced air handler/furnace system with an HRV/ERV

This application provides filtration of all Outdoor Air (OA) that is brought into the home through the HRV/ERV, thus reducing the introduction of dust, pollen and mold from the outdoor air. For systems that have HRV/ERV units installed, we recommend ducting the 'fresh air' outflow from the HRV/ERV into the HEPA system. If the HRV/ERV CFM (cubic feet per minute) rating is lower than that of the HEPA system, an additional return needs to be installed into the HEPA system (See figure 8.) The outflow air from the HEPA system then needs to be installed into the main return of the air handler/furnace system. Ensure that you follow the proper installation instructions as outlined in the HRV/ERV Installation manual(s).

Preparation:

Here are some things to consider as you decide where to install the HEPA system with an HRV/ERV.

Location:

- Make sure there is room to open the HEPA filter access panel for filter changes/inspections.
- Keep the HEPA system in a location where you can still access the air handler/furnace filter.
- Keep the HEPA system away from possible water damage
- Vibration pads will reduce vibration for installations where the unit is placed on the floor.
- Install HEPA System on floor or suspended platform. If the unit is suspended, screws must not penetrate through the cabinet. Make sure that you have the proper chains/straps/joists and equipment to keep unit secure.

Intake (Marked as 'Air In' on unit):

- Most HRV/ERV systems will not move as much air as the HEPA system. For these systems, install an additional return from another treated air source into the HEPA system.
- If using an additional return duct, it should be installed upstream of any humidifiers. The fresh air outflow of the HRV/ERV should be "Y" connected to the additional return duct then connected to the inlet of the HEPA system.
- The additional return duct (if any) should be installed at least 6 ft. away from the outflow duct on the main return.
- Duct both the HRV/ERV and the additional return into the intake of the HEPA system.

Outflow (Marked as 'Clean Air Out' on unit):

- Outflow duct should be installed as close to the air handler/furnace inlet as possible but not directly into the return air elbow of the main return.

Ducting:

- If HEPA system is installed where inlet and outflow collars face down, metal elbows must be connected to both inlet and outflow collars.
- Each connection must be sealed with aluminum tape or

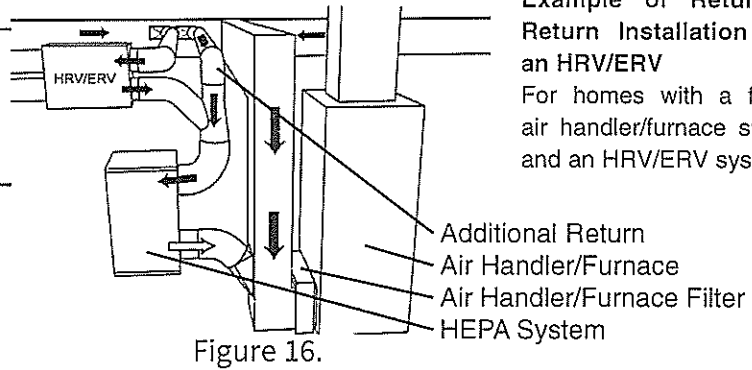

Figure 16.

Example of Return to Return Installation with an HRV/ERV

For homes with a forced air handler/furnace system and an HRV/ERV system.

NOTE: This filtration system is an **ADDITIONAL** filter, and does **NOT** replace the existing air handler/furnace system filter.

mastic, including all take offs.

- Installed duct runs should be as straight as possible (if the duct runs are too long, reduced CFM may result).
- If duct is exposed to unconditioned air, externally insulated flex duct is highly recommended.
- Externally insulated flex duct can also be used for noise reduction purposes.
- For best indoor air quality, do not use ductboard or fiberglass inside of ducts.

Electricity:

- The unit must be plugged into a grounded 120V, 60Hz outlet.

Required Materials for Installation of Unit:

Items for AWW-350

| | |
|--|---------------------|
| Flex or rigid duct (length as required) | 8" round & 6" round |
|--|---------------------|

| | |
|----------|-----------------|
| Takeoffs | One 8" & One 6" |
|----------|-----------------|

Items for AWW-675

| | |
|--|----------------------|
| Flex or rigid duct (length as required) | 10" round & 8" round |
|--|----------------------|

| | |
|----------|------------------|
| Takeoffs | One 10" & One 8" |
|----------|------------------|

All Models

Aluminum tape or mastic as required

Misc. hanging materials - field provided

NOTE: Be sure to review 'Rules for Safe Installation and Operation' on page 1 of this document before start-up of this unit.

Dealer Installation Instructions

Independent Operation:

The HEPA systems can be used independently of any other equipment! The intake and outflow of the filtration system can be ducted into the same room to create a cleaner environment almost anywhere. The intake or outflow can also be ducted elsewhere. The intake and outflow should be installed on opposite sides of the room; however, this varies according to your specific needs.

Preparation:

Here are some things to consider as you decide where to install the HEPA system independently of other systems.

Location:

- Make sure there is room to open the HEPA filter access panel for filter changes/inspections.
- Keep the HEPA system away from possible water damage
- Vibration pads will reduce vibration for installations where the unit is placed on the floor.
- Install HEPA System on floor or suspended platform. If the unit is suspended, screws must not penetrate through the cabinet. Make sure that you have the proper chains/straps/joists and equipment to keep unit secure.

Intake (Marked as 'Air In' on unit):

- Intake ducts should be installed near the floor for optimum airflow (see figure 11). If space does not allow, then the inlet can be installed in the ceiling.
- Intake duct should be installed at least 6 ft. away from the outflow duct.
- Intake duct should be installed at opposite end of the room from the outflow duct(s) if in the same room.
- Diffusers are recommended to help distribute airflow evenly.

Outflow (Marked as 'Clean Air Out' on unit):

- Outflow(s) should be installed in the ceiling away from any other air inlet(s)
- Room diffusers are recommended to help distribute airflow evenly in the occupied space.

Ducting:

- If HEPA system is installed where inlet and outflow collars face down, metal elbows must be connected to both inlet and outflow collars.
- Each connection must be sealed with aluminum tape or mastic, including all vent connections.
- Installed duct runs should be as straight as possible (if the duct runs are too long, reduced CFM may result).
- If duct is exposed to unconditioned air, insulated flex duct is highly recommended.
- Externally insulated flex duct can also be used for noise

Example of Single Room Stand Alone System Installation

For single rooms where increased filtration is desired such as a dedicated 'smoking room'.

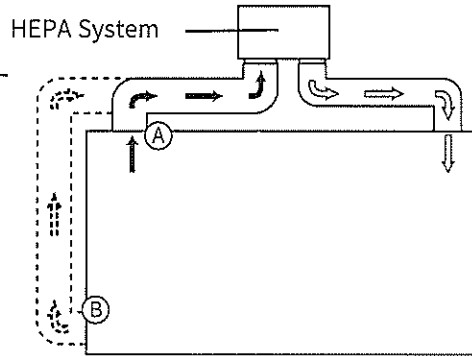

Air should be drawn from location B if space is available, otherwise, use location A.

Figure 17.

reduction purposes.

- For best indoor air quality, do not use ductboard or fiberglass inside of ducts.

Electricity:

- The unit must be plugged into a grounded 120V, 60Hz. outlet.

Required Materials for Installation of Unit:

Items for AWW-350

| | |
|--|---------------------|
| Flex or rigid duct (length as required) | 8" round & 6" round |
| Takeoffs | One 8" & One 6" |
| Diffusers | One 8" & One 6" |

Items for AWW-675

| | |
|--|----------------------|
| Flex or rigid duct (length as required) | 10" round & 8" round |
| Takeoffs | One 10" & One 8" |
| Diffusers | One 10" & One 8" |

All Models

Aluminum tape or mastic as required
Misc. hanging materials - field provided

NOTE: Be sure to review 'Rules for Safe Installation and Operation' on page 1 of this document before start-up of this unit.

Operation

1. Make sure that the unit is plugged into a grounded outflow (120 Volt, 60 Hz).
2. For optimum performance, the HEPA system should operate when the indoor air handler/furnace blower is on.
3. Turn the unit on by pressing the on/off switch to the '1' position. The switch should light up when the unit is on.
4. To turn the unit off, press the on/off switch to the '0' position. The switch light should turn off when the unit is off.

Maintenance

Proper care and maintenance of your HEPA system will ensure years of service. The unit must be turned off during service/maintenance or when filters are being changed.

It is recommended that gloves and a filtered breathing mask be worn during filter replacement.

| | |
|--|---|
|  | WARNING |
| | Electrical Shock Hazard. Can cause injury or death. Disconnect all electrical power supplies before servicing. Do not operate equipment without access panels in place. |

| | |
|---|--|
|  | CAUTION |
| | Risk of Sharp Edges Hazard. Equipment sharp edges can cause injuries. Avoid grasping equipment edges without protective gloves. |

Filter Change Schedule

Note: Failure to properly maintain your HEPA system will decrease the efficiency and air flow.

Foam Pre-Filter: 3 to 4 months*

HEPA Filter: 2 to 5 years

Inner Carbon Filter: 6 months

Optional Carbon Canister: 12 months

* The foam pre-filters can be washed and reused

NOTE: Filter life is based on average air content. Some filters may need to be changed more often due to higher amounts of dust, humidity, or chemicals found in your ambient air. Additionally, people who are more sensitive to these airborne contaminants may desire more frequent filter changes.

Filter Changing Guidelines

Pre-Filter:

Dust and other large particles will collect on the pre-filter over time. The color of the filter will change as particulates build up on the pre-filter. Change the pre-filter when you can see the particulate build up start to clog the pre-filter.

HEPA Filter:

As the HEPA filter captures particulates, it will darken over time. Replace the HEPA filter when it darkens to the level seen in example D.

A. New



B. Used



C. Used



D. Replace



Inner Carbon Filter:

The inner carbon filter will rarely look used. This filter captures odors and gasses, yet the filter's appearance will not change. When this filter has reached its maximum adsorbency of odors and gasses, it will no longer work. Replace this filter when it no longer seems to capture odors, or every 3 months (12 months for optional Carbon Canister), whichever occurs first.

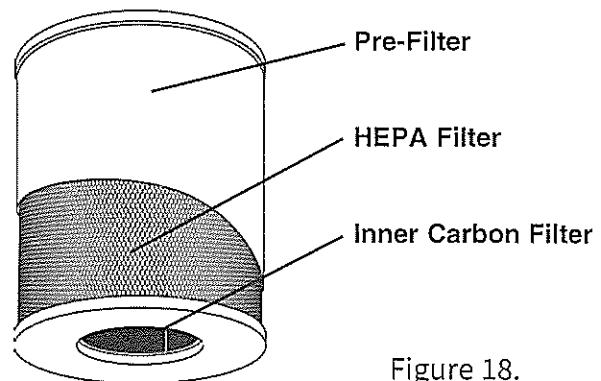



Figure 18.

Dealer Filter Change Instructions

| | |
|---|---|
|  | WARNING |
| | Electrical Shock Hazard. Can cause injury or death. Disconnect all electrical power supplies before servicing. Do not operate equipment without access panels in place. |

| | |
|---|--|
|  | CAUTION |
| | Risk of Sharp Edges Hazard. Equipment sharp edges can cause injuries. Avoid grasping equipment edges without protective gloves. |

It is recommended that gloves and a filtered breathing mask be worn during filter replacement to avoid breathing particulates (dust, mold, pollen, etc.) captured on the filter that become airborne during the filter(s) changeout.

The old filters should be wrapped and sealed in plastic bags immediately upon removal from the unit to avoid distributing particles throughout the house during the process of disposal.

1. Accessing the filters

- Remove safety screw(s) from HEPA filter access panel.
- Unlatch the two retaining clips and lift off HEPA filter access panel.
- Bracing the unit so it does not move, turn the HEPA cartridge counter-clockwise and lift/pull out.

2. Pre-filter Replacement

- Pull the pre-filter up and off the unit. NOTE: The pre-filter may contain contaminants, remove it slowly to avoid releasing particles back into the air.
- Foam pre-filters can be washed several times, wash by hand in warm water. Let it dry completely before placing it back onto the HEPA cartridge.
- If replacing the filter, remove plastic shrink wrap from the new pre-filter.
- Stretch the new/washed filter around the top of the HEPA cartridge and slide it down into place

3. Inner Carbon Filter Replacement

- Look inside the HEPA cartridge to locate the two ends of the inner carbon filter.
- Pull one end of the old inner carbon filter in and bend it into a loose roll so it can be removed.
- Remove the inner carbon filter from the HEPA cartridge.

- Remove plastic shrink wrap from the new inner carbon filter.
- Unroll the inner carbon filter and roll it up in the opposite direction (this makes the filter follow a more contoured profile against the inner HEPA filter surfaces and helps keep it in place), place the rolled inner carbon filter inside the HEPA cartridge and gently unroll it until the ends 'butt' together and the filter is snug against the HEPA filter.

4. HEPA Filter Replacement

- If replacing the HEPA filter with a new filter, discard old HEPA filter and use new when replacing the HEPA filter into the unit.
- With each annual filter replacement kit, a new 'o' ring is provided. The old one is removed by pinching it between two fingers and pulling it off the collar on the blower deck.
- Discard old 'o' ring.
- Place the new 'o' ring onto the collar and slide it down to the base of the blower deck.

5. Optional Carbon Canister

- Remove old carbon canister (if installed) by pulling it out from the inside of the HEPA filter.
- If replacing an inner carbon filter with the carbon canister, remove inner carbon filter by following the steps a. to c. in section 3.
- Remove the plastic shrink wrap from the new carbon canister.
- Slide the carbon canister into the HEPA cartridge, smaller end first. The carbon canister should slide all the way in until the metal edges at the base meet the HEPA filter.
- Support the carbon canister with your fingers so it does not slide out when replacing the HEPA cartridge assembly into the unit.

6. Installing the HEPA Filter Cartridge

- With the filters changed or inspected, all 3 filters are ready to be placed back into the unit. Place the HEPA cartridge gently into the unit (if a carbon canister is being used, take care not to let it slide out as it is heavy and could damage the unit)
- When the HEPA cartridge is in place, brace the unit, press down and gently turn it clockwise to lock it into place. If too much force is used, the cartridge may be difficult to remove!
- Replace the HEPA filter access panel and latch it with the two retaining clips.
- Re-install safety screw(s) into HEPA filter access panel.
- Plug the unit back into a power outflow and turn it on.

Dealer Motor Assembly Replacement Instructions

⚠ WARNING

Electrical Shock Hazard.

Can cause injury or death.

Disconnect all electrical power supplies before servicing.

Do not operate equipment without access panels in place.

Do not use this fan with any solid-state speed control device.



⚠ CAUTION

Risk of Sharp Edges Hazard.

Equipment sharp edges can cause injuries.

Avoid grasping equipment edges without protective gloves.

1. Accessing the motor assembly

- Turn the unit off and unplug it from any electrical source before opening the cabinet.
- Remove the safety screw(s) from the motor section access panel.
- Lift the door off the unit.

2. Removing the old motor assembly

- Disconnect all four motor wires from switch, ground post and capacitor.
- Disconnect the two white wires from the capacitor.
- Separate the motor from the motor mount by removing the four screws found in figure 13.
- Slide the motor out from under the motor mount to remove it from the unit.

3. Installing the new motor assembly

- Slide the new motor into the motor mount making sure that the wires go through the smaller hole offset from the center of the bracket.
- Secure the new motor to the motor mount with the four screws removed in step 2c.
- Connect the wires as follows:
 - Blue wire from motor to the on/off switch.
 - Yellow/green wire from motor to the ground post.
 - Brown wire from the motor to a capacitor post.
 - Black wire from the motor to the other capacitor post.
 - White wire from the on/off switch to the capacitor via the black wire piggyback post.
 - White wire from the power cord to the capacitor via the other white wire's piggyback post.

4. Closing the unit

- Replace the motor section access panel and secure it with the eight screws removed in step 1b.
- Plug the unit into its electrical source and turn it on.

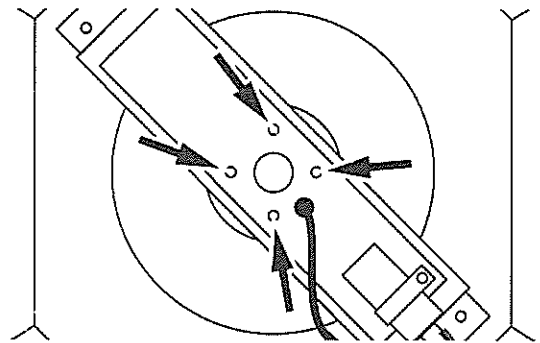

Figure 19.

Electrical Diagram

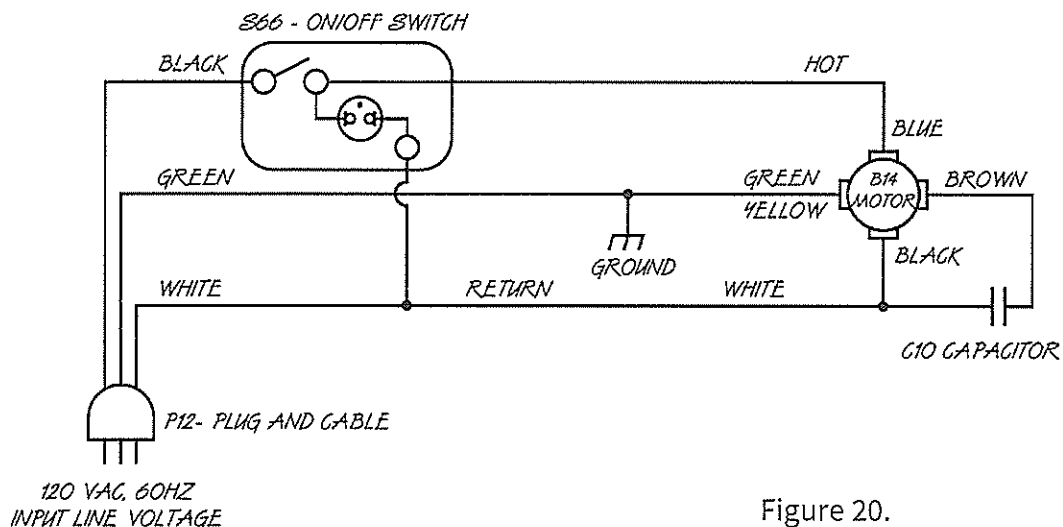

Figure 20.

Replacement Parts

| Replacement Parts for AWW-350 (Qty.) | Canadian | U.S. | International |
|--|------------|------------|---------------|
| Complete Filter Kit (1 Pre-filter, 1 HEPA, 1 Carbon) | 9100443709 | 9101443709 | 9101443709 |
| Annual Filter Kit (1 Pre-filter, 2 Carbon) | 94004061 | 94014061 | 94014061 |
| Motor Assembly (120V) | 99001200 | 99011200 | 99011200 |
| Motor Assembly (220V) | 99002800 | 99012800 | 99012800 |
| HEPA Filter Cartridge | 90004487 | 90014487 | 90014487 |
| Pre-Filter (Foam) | 92004-31 | 92014-31 | 92014-31 |
| Carbon Filter | 93004-21 | 93014-21 | 93014-21 |
| Carbon Canister 100% Carbon (1) | 95004-5 | 95014-5 | 95014-5 |
| Carbon/Zeolite Canister 60% Carbon/40% Zeolite (1) | 95004-6 | 95014-6 | 95014-6 |

| Replacement Parts for AWW-675 (Qty.) | Canadian | U.S. | International |
|--|------------|------------|---------------|
| Complete Filter Kit (1 Pre-filter, 1 HEPA, 1 Carbon) | 9100443709 | 9101443709 | 9101443709 |
| Annual Filter Kit (1 Pre-filter, 2 Carbon) | 94004061 | 94014061 | 94014061 |
| Motor Assembly (120V) | 99002400 | 99012400 | 99012400 |
| Motor Assembly (220V) | 99003000 | 99013000 | 99013000 |
| HEPA Filter Cartridge | 90004487 | 90014487 | 90014487 |
| Pre-Filter (Foam) | 92004-31 | 92014-31 | 92014-31 |
| Carbon Filter | 93004-21 | 93014-21 | 92014-21 |
| Carbon Canister - 100% Carbon (1) | 95004-5 | 95014-5 | 95014-5 |
| Carbon/Zeolite Canister - 60% Carbon/40% Zeolite (1) | 95004-6 | 95014-6 | 95014-6 |

Use this unit only in the manner intended by the manufacturer. If you have questions, contact Amaircare® at
1-800-268-7732.

Contact your local Amaircare® dealer to order replacement parts.